

# Balflex<sup>®</sup>



**HYDRAULIC  
FITTINGS  
CATALOG**

## European Technology

---

*Established since 1963, **Balflex®** is a European international group of companies dedicated to the design, production, assembly and distribution of all types of high-tech products for conduction of fluids, measuring of pressure and power transmission at very high quality level.*

*6 decades of know-how and expertise in this field, makes **Balflex®** the first choice for the mining, agriculture, off-shore and construction industries.*

*Today the **Balflex®** Group covers worldwide users through our own company's production facilities, branches and net of certified distributors.*

**Balflex®** valorizes the inside meaning of the words we use: **Excellence** the quality of being outstanding; **Innovation** the action or process of innovating; **Partnership** cooperation relationship between two or more people, having in mind a common goal; **Tradition** way of thinking or acting, inherited from previous generations.

---





# Quality

*Quality is very important for us. We have fully equipped, modern laboratories and equipment, employing the industries most experienced personnel.*

Balflex® has earned various certifications for our Management Systems and Products. This reliable and consistent approach has allowed us to achieve our ISO 9001:2015 certification. At Balflex® quality and service always comes first. We are dedicated to continue the development of new products with a strong emphasis on quality.

## Member of:



## Certified by:





## Hoses vs Ferrule Compatibility Chart

Hose vs Ferrule		1/8"	3/16"	1/4"	5/16"	3/8"	1/2"	5/8"	3/4"	1"	1.1/4"	1.1/2"	2"	2.1/2"	3"
		- 02	- 03	- 04	- 05	- 06	- 08	- 10	- 12	- 16	- 20	- 24	- 32	- 40	- 48
Balflex®	Versions	Balflit®	Balflit®	Balflit®	Balflit®	Balflit®	Balflit®	Balflit®	Balflit®	Balflit®	Balflit®	Balflit®	Balflit®	Balflit®	Balflit®
TEXMASTER 1			20.107	20.107	20.107	20.107	20.107	20.107	20.107	20.107					
TEXMASTER 2			20.107	20.107	20.107	20.107	20.107	20.107	20.107	20.107					
TEXMASTER 3				20.201	20.201	20.201	20.202	20.202	20.202	20.301	20.201	20.201	20.201		
FORZA UNO	SHARK SKIN TROPIC ARMOURGUARD		20.204 20.101	20.302 20.101	20.302 20.101	20.302 20.101	20.302 20.202	20.302 20.202	20.302 20.202	20.204 20.301	20.204 20.101	20.204 20.101	20.204 20.101	20.204	20.204
FORZA DUE	SHARK SKIN TROPIC ARMOURGUARD		20.204 20.201	20.302 20.201	20.302 20.201	20.302 20.201	20.302 20.202	20.302 20.202	20.302 20.202	20.204 20.302	20.204 20.201	20.204 20.201	20.204 20.201	20.204	20.204
BALPAC PREMIUM	SHARK SKIN TROPIC ARMOURGUARD			20.302	20.302	20.302	20.302	20.302	20.302	20.204					
IMPACTUS 5K	SHARK SKIN ARMOURGUARD			20.302	20.302	20.302	20.302	20.302	20.302	20.204					
IMPACTUS 6K	SHARK SKIN ARMOURGUARD			20.302	20.302	20.302	20.302	20.302	20.302	20.204					
BALPAC 3000	SHARK SKIN TROPIC ARMOURGUARD			20.305	20.305	20.305	20.305	20.302	20.302	20.204					
2-MAX				20.302		20.302	20.302								
3-MAX						20.200	20.200	20.200	20.200	20.200					
BALWASH 1W	SHARK SKIN			20.302 20.101	20.302 20.101	20.302 20.101	20.302 20.202								
BALWASH 2W	SHARK SKIN			20.302 20.201	20.302 20.201	20.302 20.201	20.302 20.202								
BALMASTER 4SP	ARMOURGUARD			20.200		20.200 20.NS4	20.200 20.NS4	20.200 20.NS4	20.200 20.NS4	20.200 20.NS4	20.200 20.NS4	20.200 20.NS4	20.200 20.NS4		
BALMASTER R12	ARMOURGUARD					20.NS4	20.NS4	20.NS4	20.NS4	20.NS4	20.NS4	20.NS4	20.NS4		



Hose vs Ferrule		1/8"	3/16"	1/4"	5/16"	3/8"	1/2"	5/8"	3/4"	1"	1.1/4"	1.1/2"	2"	2.1/2"	3"
		- 02	- 03	- 04	- 05	- 06	- 08	- 10	- 12	- 16	- 20	- 24	- 32	- 40	- 48
Balflex®	Versions	Balfit®	Balfit®	Balfit®	Balfit®	Balfit®	Balfit®	Balfit®	Balfit®	Balfit®	Balfit®	Balfit®	Balfit®	Balfit®	Balfit®
POWERSPIR 4SH	ARMOURGUARD									20.NS4 20.406	20.NS4 20.406	20.NS4 20.405	20.NS4 20.405	20.NS4 20.405	
POWERSPIR R13	ARMOURGUARD									20.NS4 20.406	20.NS4 20.406	20.406	20.406	20.406	
POWERSPIR R15	ARMOURGUARD									20.NS4 20.406	20.NS4 20.406	20.406	20.406	20.406	
BALFLON R14	BLACK	20.107	20.107	20.107	20.107	20.107	20.107	20.107	20.107	20.107	20.107				
BALFLON CONVOLUTED	BLACK			20.107	20.107	20.TFC	20.TFC	20.TFC	20.TFC	20.TFC	20.TFC	20.TFC	20.TFC	20.TFC	
ZETAFLEX	TWIN NON CONDUCTIVE	20.107	20.107	20.107	20.107	20.107	20.107	20.107	20.107	20.107	20.107				
ZETAFLEX STEEL	TWIN	20.107	20.107	20.107	20.107	20.107	20.107	20.107	20.107	20.107	20.107				
OMEGAFLEX PLUS	TWIN NON CONDUCTIVE	20.107	20.107	20.107	20.107	20.107	20.107	20.107	20.107	20.107	20.107				

## Hose Fittings Pressure Ratings

For each type of fitting there is a maximum working pressure recommended in table below. Whenever information is not available, contact the manufacturer.

		Inch Fittings (size)												
		Maximum Working pressure (MPa/psi) – safety factor 4:1												
Description	Part Number	-2	-3	-4	-5	-6	-8	-10	-12	-16	-20	-24	-32	
NPTF Male	XX.0400 XX.0410 XX.0490	34.5 5000		27.6 4000		20.7 3000	20.7 3000			17.2 2500	13.8 2000	7.9 1150	6.9 1000	6.9 1000
BSP Male	XX.0100	42.0 6090		45.0 6525		40.0 5800	40.0 5800	40.0 5800	38.0 5510	34.5 5003	24.0 3480	21.0 3045	17.2 2494	
BSP Swivel Female	XX.3012 XX.3042 XX.3092	42.0 6090		45.0 6525		40.0 5800	40.0 5800	40.0 5800	38.0 5510	34.5 5003	24.0 3480	21.0 3045	17.2 2494	
BSP Swivel Female with O-ring	XX.3112 XX.3142 XX.3192			45.0 6525		40.0 5800	40.0 5800	40.0 5800	38.0 5510	34.5 5003	24.0 3480	21.0 3045	17.2 2494	
JIC 37° Male	XX.2000			35.0 5075	35.0 5075	35.0 5075	31.0 4495	24.0 3480	24.0 3480	21.0 3045	17.0 2465	14.0 2030	10.5 1523	
JIC 37° Swivel Female	XX.4012 XX.4042 XX.4092 XX.4H12			35.0 5075	35.0 5075	35.0 5075	31.0 4495	24.0 3480	24.0 3480	21.0 3045	17.0 2465	14.0 2030	10.5 1523	
Flange 3000 PSI	XX.7013 XX.7043 XX.7093						34.5 5000	34.5 5000	34.5 5000	34.5 5000	27.6 4000	20.7 3000	17.2 2500	
Flange 6000 PSI	XX.7016 XX.7046 XX.7096						41.4 6000	41.4 6000		41.4 6000	41.4 6000	41.4 6000	41.4 6000	
ORFS Male	XX.4000			63.0 9135		63.0 9135	63.0 9135	40.0 5800	40.0 5800	40.0 5800	25.0 3625	25.0 3625		
ORFS Female	XX.4414 XX.4444 XX.4494 XX.44H4			63.0 9135		63.0 9135	63.0 9135	40.0 5800	40.0 5800	40.0 5800	25.0 3625	25.0 3625		

The Working Pressure of the hose assembly shall be the lower of the pressures given for its sizes in the fittings standards and in the the relevant hose specification.

With our thick Zinc coating, Cr-VI free zinc plating process, a high corrosion resistance on all our carbon steel products is achieved, in compliance with EU and USA regulation, as well as with all relevant fitting standards, such as SAE J516 and DIN EN ISO 12151.

Due to exclusion of hexavalent chromium, we assure an environment friendly final product, without compromising the corrosion resistance.

Our zinc-plating when tested according to EN ISO 9227 guarantees minimum 240 hours, before appearance of corrosion.

(The presented values are measured before crimping operation)



<b>Metric Tube (mm) – Light Serie "L"</b>											
Maximum Working pressure (MPa/psi) – safety factor 4:1											
Description	Part Number	6	8	10	12	15	18	22	28	35	42
Metric Male	XX.1000	25.0 3625	25.0 3625	25.0 3625	25.0 3625	25.0 3625	16.0 2320	16.0 2320	10.0 1450	10.0 1450	10.0 1450
Metric Swivel Female with O-ring	XX.5013 XX.5043 XX.5093	25.0 3625	25.0 3625	25.0 3625	25.0 3625	25.0 3625	16.0 2320	16.0 2320	10.0 1450	10.0 1450	10.0 1450

<b>Metric Tube (mm) – Heavy Serie "S"</b>											
Maximum Working pressure (MPa/psi) – safety factor 4:1											
Description	Part Number	6	8	10	12	14	16	20	25	30	38
Metric Male	XX.1100	63.0 9135	63.0 9135	63.0 9135	63.0 9135	63.0 9135	40.0 5800	40.0 5800	40.0 5800	25.0 3625	25.0 3625
Metric Swivel Female with O-ring	XX.5113 XX.5143 XX.5193	63.0 9135	63.0 9135	63.0 9135	63.0 9135	63.0 9135	40.0 5800	40.0 5800	40.0 5800	25.0 3625	25.0 3625

The Working Pressure of the hose assembly shall be the lower of the pressures given for its sizes in the fittings standards and in the the relevant hose specification.

With our thick Zinc coating, Cr-VI free zinc plating process, a high corrosion resistance on all our carbon steel products is achieved, in compliance with EU and USA regulation, as well as with all relevant fitting standards, such as SAE J516 and DIN EN ISO 12151.

Due to exclusion of hexavalent chromium, we assure an environment friendly final product, without compromising the corrosion resistance.

Our zinc-plating when tested according to EN ISO 9227 guarantees minimum 240 hours, before appearance of corrosion.

(The presented values are measured before crimping operation)



## The Correct Method to Fit Female Swivel Ends

To ensure a leakproof seal between swivel female hose ends shown in this catalogue and the appropriate adaptors it is necessary to follow the procedure below which is different from hydraulic tube assembly (This instruction is not valid for ORFS fittings).

### Metal-to-metal seal

Screw the nut up hand tight and then with a spanner for one further 1/4 turn only.

### Soft seal by O-ring

Screw the nut up hand tight and then with a spanner for one further 1/4 turn only.



Ensure that in all cases the hose is correctly aligned before tightening the nut onto the corresponding adaptor.

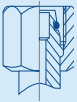

## Spanner Torque Values

Metric swivel female			
 Thread Metric	Tube O.D.	Nm	
		nominal	min. - max.
M 12x1,5	06L	16	15 - 17
M 14x1,5	08L	16	15 - 17
M 16x1,5	10L	26	25 - 28
M 18x1,5	12L	37	35 - 39
M 22x1,5	15L	47	45 - 50
M 26x1,5	18L	89	85 - 94
M 30x2	22L	116	110 - 121
M 36x2	28L	137	130 - 143
M 45x2	35L	226	215 - 237
M 52x2	42L	347	330 - 363
M 14x1,5	06S	26	25 - 28
M 16x1,5	08S	42	40 - 44
M 18x1,5	10S	53	50 - 55
M 20x1,5	12S	63	60 - 66
M 22x1,2	14S	79	75 - 83
M 24x1,5	16S	84	80 - 88
M 30x2	20S	126	120 - 132
M 36x2	25S	179	170 - 187
M 42x2	30S	263	250 - 275
M 52x2	38S	368	350 - 385

BSP swivel female			
 Thread BSPP	Size	Nm	
		style A	style B
G1/8	-2	-	10
G1/4	-4	20	20
G3/8	-6	35	35
G1/2	-8	50	60
G5/8	-10	60	70
G3/4	-12	85	115
G1	-16	115	140
G1.1/4	-20	190	210
G1.1/2	-24	240	290
G2	-32	300	400



JIC 37° Swivel Female		
		
Thread UNF	Size	Nm +10% -0%
7/16-20	-4	15
1/2-20	-5	19
9/16-18	-6	24
3/4-16	-8	49
7/8-14	-10	77
1.1/16-12	-12	107
1.5/16-12	-16	147
1.5/8-12	-20	172
1.7/8-12	-24	215
2.1/2-12	-32	332

ORFS Swivel Female		
		
Thread UNF	Size	Nm +10% -0%
9/16-18	-4	25
11/16-18	-6	40
13/16-16	-8	55
1-14	-10	60
1.3/16-12	-12	90
1.5/16-12	-14	115
1.7/16-12	-16	125
1.11/16-12	-20	170
2-12	-24	200

The torque values for other materials are as follows:

- **Brass fittings and adapters**  
65% of the torque value for steel.
- **Stainless steel**  
use high side of the torque range for steel.  
threads to be lubricated for these materials.
- **Dissimilar metals**  
use torque value designated for the lower of the two materials.
- **All fittings are dry except as noted above.**

#### Note

Values given in tables are typical to achieve the recommended assembly methods when fitting material is steel zinc plated. For other materials different values will be applicable.

## Quick identification of hydraulic connectors

### DIN 24° light (L) and heavy series (S) with O-ring

The male has a 24° sealing angle cone seat with straight metric threads. The female has a 24° convex cone with O-ring and a swivel straight metric threaded nut.

Standard: ISO 12151-2, ISO 8434-1, ISO 8434-4

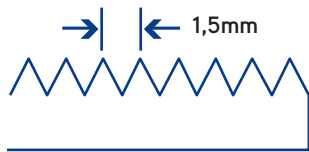
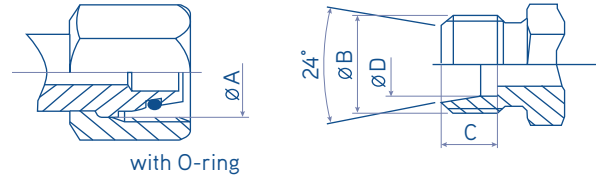

#### Thread

Defined by the outside diameter and the pitch (distance between 2 crests of the thread)  
example: M22x1.5 - pitch of 1.5mm.

Tube O.D. (mm)	Tube type	Thread metric	ØA (mm)	ØB (mm)	C (mm)	ØD (mm)
6.00	6L	M12x1.5	10.50	12.00	7.00	6.20
6.00	6S	M14x1.5	12.50	14.00	7.00	6.20
8.00	8L	M14x1.5	12.50	14.00	7.00	8.20
8.00	8S	M16x1.5	14.50	16.00	7.00	8.20
10.0	10L	M16x1.5	14.50	16.00	7.00	0.20
10.0	10S	M18x1.5	16.50	18.00	7.50	0.20
12.0	12L	M18x1.5	16.50	18.00	7.00	2.20
12.0	12S	M20x1.5	18.50	20.00	7.50	2.20
14.0	14S	M22x1.5	20.50	22.00	8.00	14.20
15.0	15L	M22x1.5	20.50	22.00	7.00	15.20
16.0	16S	M24x1.5	22.5	24.0	8.5	16.20
18.0	18L	M26x1.5	24.5	26.0	7.50	18.20
20.0	20S	M30x2.0	27.9	30.0	10.50	20.20
22.0	22L	M30x2.0	27.9	30.0	7.50	22.20
25.0	25S	M36x2.0	33.9	36.0	12.00	25.20
28.0	28L	M36x2.0	33.9	36.0	7.50	28.20
30.0	30S	M42x2.0	39.9	42.0	13.50	30.20
35.0	35L	M45x2.0	42.9	45.0	10.50	35.30
38.0	38S	M52x2.0	49.9	52.0	16.00	38.30
42.0	42L	M52x2.0	49.9	52.0	11.00	42.30



## British Standard Pipe Parallel (BSPP)

Referred to as Whitworth threads, the BSP thread type fittings seal use metal-to-metal angled surfaces or a combination of metal-to-metal and an O-ring. The angle of the sealing surfaces is 60° for both forms. Standard: BS 5200 ISO 12151-6

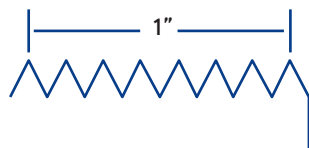
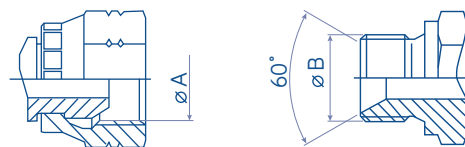

### Thread

Identification is made by measuring the outside diameter of the thread and the number of threads per inch (25.4mm).

Tube I.D. (mm)	Tube O.D. (mm)	Size	Thread BSP	ØA (mm)	ØB (mm)
6	10	- 2	1/8" -28	8.60	9.70
8	13	- 4	1/4" -19	11.50	13.20
12	17	- 6	3/8" -19	14.90	16.70
15	21	- 8	1/2" -14	18.60	20.90
18	23	- 10	5/8" -14	20.60	22.90
20	27	- 12	3/4" -14	24.10	26.40
26	34	- 16	1" -11	30.3	33.20
33	42	- 20	1.1/4" -11	38.90	41.90
40	49	- 24	1.1/2" -11	44.90	47.80
50	60	- 32	2" -11	56.70	59.60

## British Standard Pipe Tapered (BSPT)

Fittings seal through the thread interface mechanism. Care should be taken not to confuse the BSPT fitting with the NPTF male fitting. BSPT has a 55° thread angle.

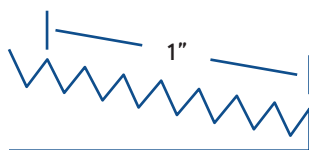
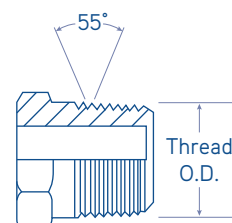

### Thread

Identification is made by measuring the outside diameter of the thread and the number of threads per inch (25.4mm).

Tube I.D. (mm)	Tube O.D. (mm)	Size	Thread BSPT	ØA (mm)
5	10	- 2	1/8" -28	9.73
8	13	- 4	1/4" -19	13.16
12	17	- 6	3/8" -19	16.66
15	21	- 8	1/2" -14	20.96
20	27	- 12	3/4" -14	26.44
26	34	- 16	1" -11	33.25
33	42	- 20	1.1/4" -11	41.91
40	49	- 24	1.1/2" -11	47.80
50	60	- 32	2" -11	59.61
50	60	- 32	2" -11	56.70

## BSP Flat Seal

These fittings have BSP parallel threads but the sealing surface is flat. The seal is made when the composite seal is compressed against the female flat face.

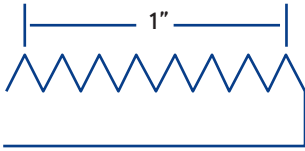
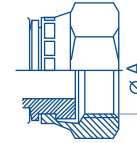

### Thread

Identification is made by measuring the outside diameter of the thread and the number of threads per inch (25.4mm).

Tube I.D. (mm)	Tube O.D. (mm)	Size	Thread BSPT	ØA (mm)
6	10	- 2	1/8" -28	8.60
8	13	- 4	1/4" -19	11.50
12	17	- 6	3/8" -19	14.90
15	21	- 8	1/2" -14	18.60
18	23	- 12	5/8" -14	20.60
20	27	- 16	3/4" -14	24.10
26	34	- 20	1" -11	30.30
33	42	- 20	1.1/4" -11	38.90
40	49	- 24	1.1/2" -11	44.90
50	60	- 32	2" -11	56.70

## Dry Seal American Standard Taper Pipe Thread (NPTF)

This type of fitting uses the thread interface to seal and as such has a tapered thread that deforms and forms the seal. They have 30° sealing angle surfaces, forming a 60° inverted (concave) seat.

Standard: SAE J476 / ANSI/ASME B1.20.1

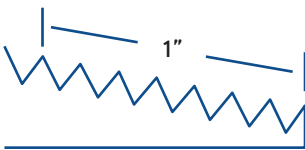
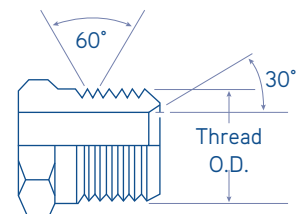

### Thread

Identification is made by measuring the outside diameter of the thread and the number of threads per inch (25.4mm).

Size	Thread NPTF	ØA (mm)
- 2	1/8" -27	10.24
- 4	1/4" -18	13.61
- 6	3/8" -18	17.05
- 8	1/2" -14	21.22
- 12	3/4" -14	26.56
- 16	1" -11.5	33.22
- 20	1.1/4" -11.5	41.98
- 24	1.1/2" -11.5	48.05
- 32	2" -11.5	60.09



## SAE JIC 37°

Commonly referred to as JIC fittings, these metal-to-metal sealing type fittings have a 37° flare (sealing surface angle) and straight United National Fine Threads (UNF). The original design specification for the fittings comes from the Society of Automotive Engineers (SAE).

Standard: ISO 12151-5, ISO 8434-2, SAE J516

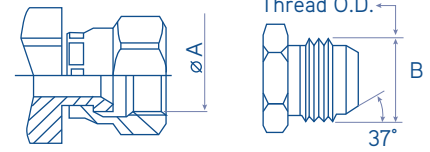

Tube O.D (inch)	Size	Thread UNF	ØA (mm)	ØB (mm)
1/4"	- 4	7/16" -20	10.00	11.10
5/16"	- 5	1/2" -20	11.60	12.70
3/8"	- 6	9/16" -18	13.00	14.30
1/2"	- 8	3/4" -16	17.60	19.10
5/8"	- 10	7/8" -14	20.50	22.20
3/4"	- 12	1.1/16" -12	24.60	27.00
7/8"	- 14	1.3/16" -12	28.30	30.10
1"	- 16	1.5/16" -12	31.30	33.30
1.1/4"	- 20	1.5/8" -12	39.20	41.30
1.1/2"	- 24	1.7/8" -12	45.60	47.60
2"	- 32	2.1/2" -12	61.50	63.50

## O-Ring Face Seal (ORFS)

This fitting type have high level of sealing and good vibration resistance. The fittings use the O-ring compression mechanism to seal. The female fittings have flat faces and straight threaded UNF swivel nuts. The male fittings have the O-ring in a groove in the flat face.

Standard: ISO 12151-1, ISO 8434-3, SAE J516

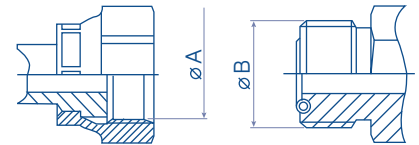

Tube O.D (inch)	Size	Thread UNF	ØA (mm)	ØB (mm)
1/4"	- 4	9/16" -18	13.00	14.20
3/8"	- 6	11/16" -16	15.90	17.50
1/2"	- 8	13/16" -16	19.10	20.60
5/8"	- 10	1" -14	23.80	25.40
3/4"	- 12	1.3/16" -12	28.20	30.10
1"	- 16	1.7/16" -12	34.15	36.50
1.1/4"	- 20	1.11/16" -12	40.50	42.90
1.1/2"	- 24	2" -12	48.80	50.80



## Flange 3000 psi and 6000 psi

The sealing mechanism is through compression of the O-ring in the face of the flange head against the surface of the port connection. The flange fittings are generally separated into two pressure classes referred to as 21.0 MPa/ 3000 psi (SFL) or 42.0 MPa/ 6000 psi (SFS). In addition to these flanges, customer-specific Komatsu and CATERPILLAR flanges can also be found in the market. Standard: ISO 6162-1, ISO 6162-2

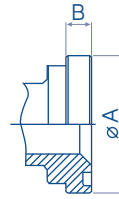

Flange (inch)	Size	3000 psi			6000 psi			SuperCat		
		ØA (mm)	B (mm)	O-ring (mm)	ØA (mm)	B (mm)	O-ring (mm)	ØA (mm)	B (mm)	O-ring (mm)
1/2"	- 8	30.18	6.73	18.64x3.53	31.75	7.75	18.64x3.53	31.75	14.22	18.64x3.53
5/8"*	- 10	34.25	6.00	21.70x3.53						
3/4"	- 12	38.10	6.73	24.99x3.53	41.28	8.76	24.99x3.53	41.28	14.22	24.99x3.53
1"	- 16	44.45	8.00	32.92x3.53	47.63	9.53	32.92x3.53	47.63	14.22	32.92x3.53
1.1/4"	- 20	50.80	8.00	37.69x3.53	53.98	10.29	37.69x3.53	53.98	14.22	37.69x3.53
1.1/2"	- 24	60.33	8.00	47.22x3.53	63.50	12.57	47.22x3.53	63.50	14.22	47.22x3.53
2"	- 32	71.42	9.53	56.74x3.53	79.38	12.57	56.74x3.53	79.38	14.22	56.74x3.53
2.1/2"	- 40	84.12	9.53	69.44x3.53						
3"	- 48	101.60	9.53	85.32x3.53						

\* Although not in the SAE or the ISO standard the size -10 (5/8) flange head is gaining popularity. This flange is often found on Komatsu equipment or hydrostatic drives in agricultural machines.

## Japanese Industrial Standard (JIS)

The Japanese Industrial Standard (JIS) uses a 30° sealing angle seat and either British Standard Pipe Parallel or metric threads.

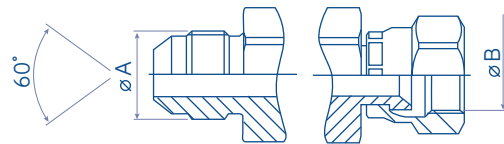

Thread metric	ØA (mm)	ØB (mm)	Thread BSP	ØA (mm)	ØB (mm)
M14X1.5	12.50	14.00	1/4" -19	11.50	13.20
M18X1.5	16.50	18.00	3/8" -19	14.90	16.70
M16X1.5	14.50	16.00	1/2" -14	18.60	20.90
M18X1.5	16.50	18.00	3/4" -14	24.10	26.40
M22X1.5	20.50	22.00	1" -11	30.30	33.20
M24X1.5	22.50	24.00			
M30X1.5	28.50	30.00			
M33X2.0	31.00	33.00			
M42X2.0	40.00	42.00			



# Ferrules

---

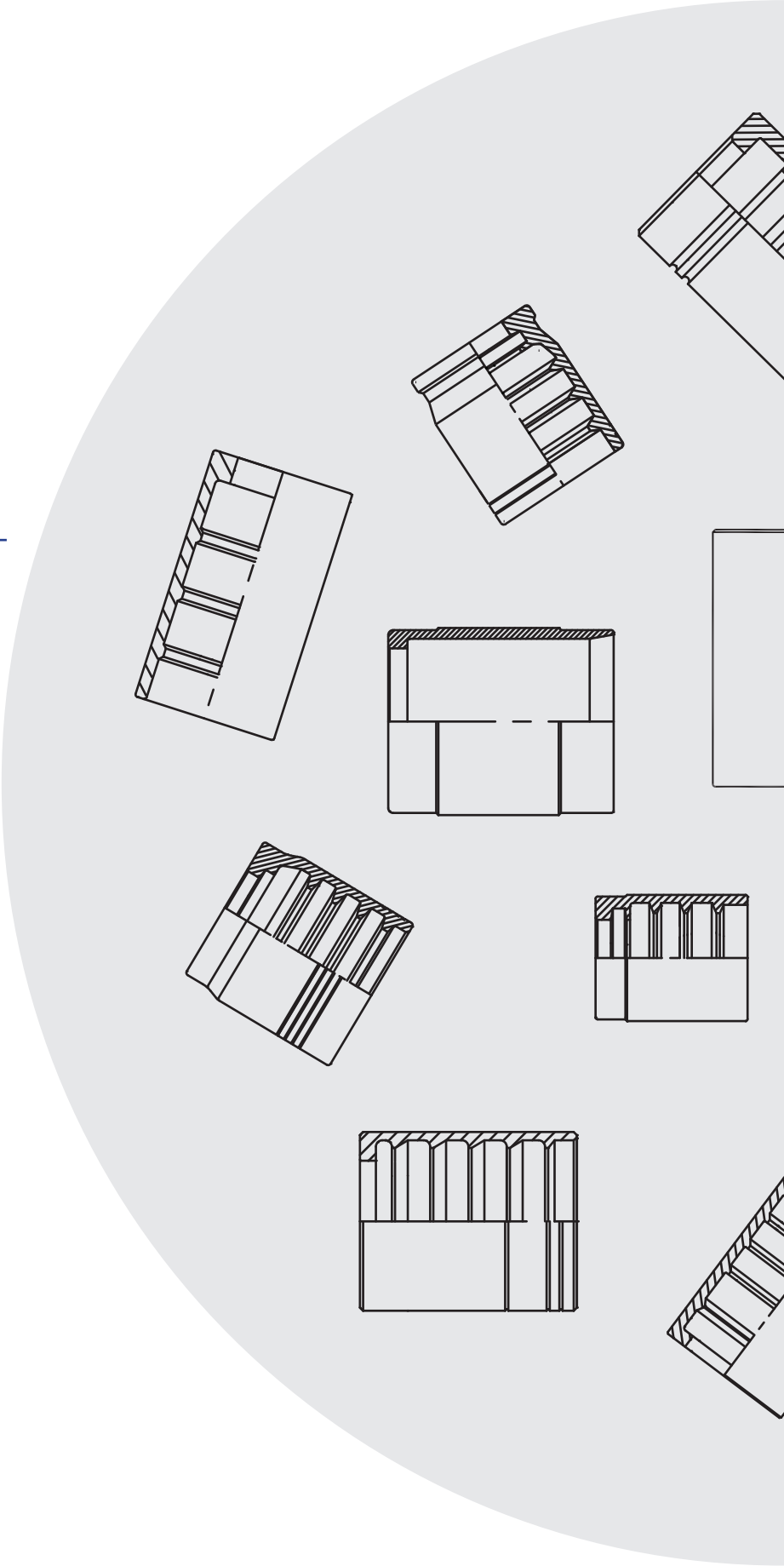

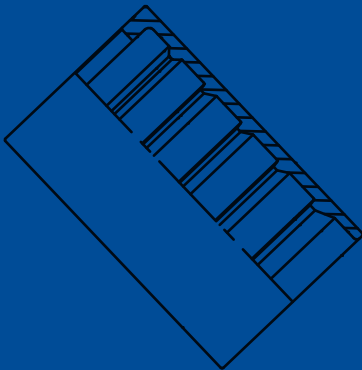
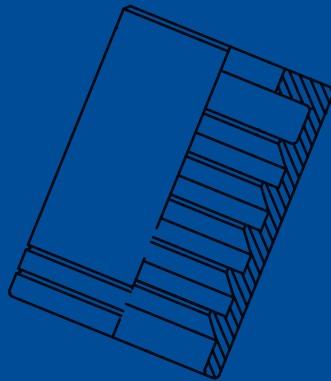
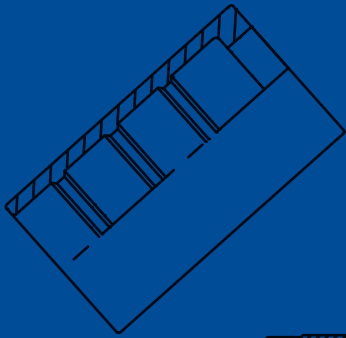
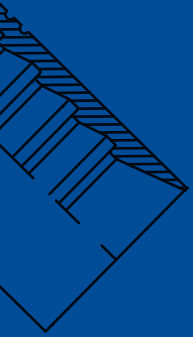

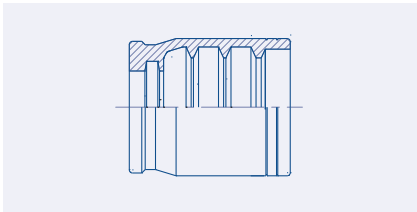

**NON SKIVE Balfit®  
1 & 2 Wire Braid Ferrule**

20.204 / 20.302

pag. 19

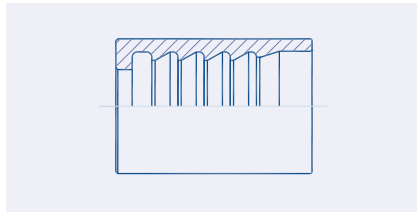

**NON SKIVE Balfit®  
1 Wire Braid Ferrule**

20.101 / 20.301

pag. 20

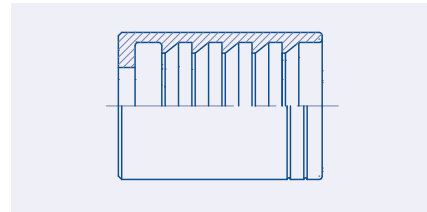

**NON SKIVE Balfit®  
2 Wire Braid Ferrule**

20.201 / 20.302

pag. 20

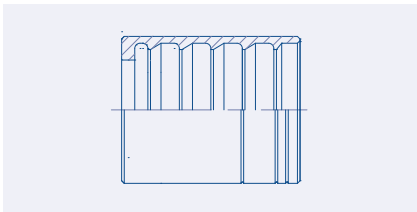

**NON SKIVE Balfit®  
1 & 2 Wire Braid Ferrule**

20.202

pag. 21

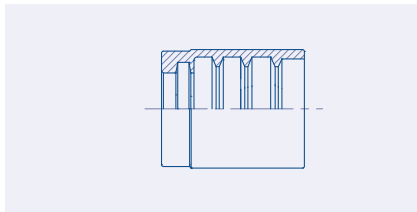

**NON SKIVE Balfit®  
1 Wire Braid Ferrule**

20.305

pag. 21

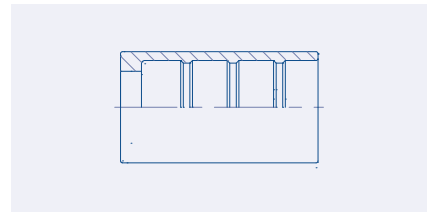

**NON SKIVE Balfit® Textile Braid,  
Thermoplastic & PTFE Ferrule**

20.107

pag. 22

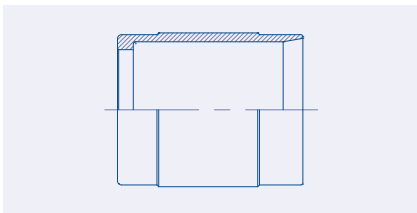

**NON SKIVE Balfit®  
PTFE Convoluted Ferrule**

20.TFC

pag. 23

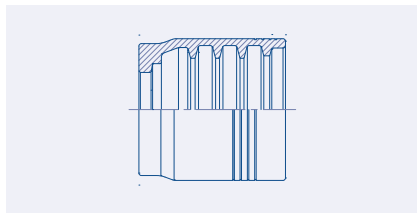

**NON SKIVE Balfit®  
4 Spiral Ferrule**

20.NS4

pag. 23

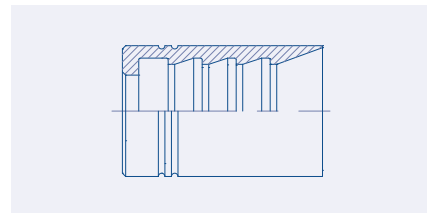

**EXTERNAL SKIVE Balfit®  
2 Wire Braid & 4 Spiral Ferrule**

20.200

pag. 24

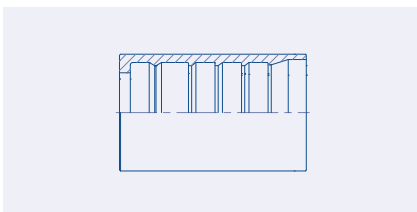

**DOUBLE SKIVE Balfit®  
4 Spiral Ferrule**

20.405

pag. 24

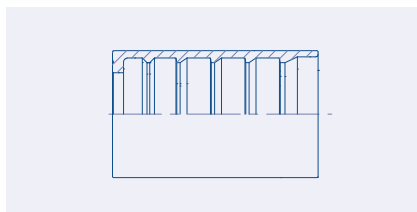

**DOUBLE SKIVE Balfit®  
4 & 6 Spiral Ferrule**

20.406

pag. 25



# NON SKIVE Balfit® 1 & 2 Wire Braid Ferrule

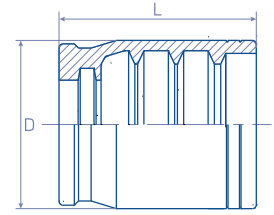

20.204. / 20.302.

REFERENCE	hose dash	hose Ø		dimensions (mm)	
		mm	inch	L	D
20.204.03	- 3	4,8	3/16"	26.0	21.0
20.302.04	- 4	6,3	1/4"	25.8	22.0
20.302.05	- 5	8,0	5/16"	27.4	24.0
20.302.06	- 6	9,5	3/8"	30.0	26.0
20.302.08	- 8	12,7	1/2"	32.5	30.0
20.302.10	- 10	16,0	5/8"	35.0	34.0
20.302.12	- 12	19,0	3/4"	40.0	38.0
20.204.16	- 16	25,4	1"	47.6	46.3
20.204.20	- 20	32,0	1-1/4"	55.0	58.0
20.204.24	- 24	38,0	1-1/2"	60.3	65.0
20.204.32	- 32	50,8	2"	62.7	78.0
20.204.40	- 40	63,0	2-1/2"	72.2	95.0
20.204.48	- 48	76,0	3"	80.0	110.0

**MATERIAL:** Carbon Steel

**FINISH:** Chromium-(VI) Free plating / **VERSIONS:** stainless steel AISI 316  
ROHS compliant

## Suitable to be used on medium and high pressure braided hoses:

FORZA UNO; FORZA UNO "SHARK SKIN"; FORZA UNO "TROPIC"; FORZA DUE; FORZA DUE "SHARK SKIN"; FORZA DUE "TROPIC"; BALPAC PREMIUM; BALPAC PREMIUM "SHARK SKIN"; IMPACTUS 5K; IMPACTUS 6K; BALPAC 3000; BALPAC 3000 "SHARK SKIN"; 2-MAX JACK; BALWASH 1W; BALWASH 2W



# NON SKIVE Balfit® 1 Wire Braid Ferrule

20.101. / 20.301.

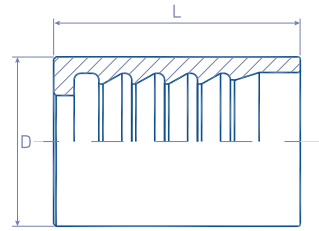

REFERENCE	hose dash	hose Ø		dimensions (mm)	
		mm	inch	L	D
20.101.03	- 3	4,8	3/16"	26.0	19.0
20.101.04	- 4	6,3	1/4"	29.0	19,8
20.101.05	- 5	8,0	5/16"	30.0	22.0
20.101.06	- 6	9,5	3/8"	31.6	24.0
20.301.16	- 16	25,4	1"	50.0	45.0
20.101.20	- 20	32,0	1.1/4"	60.0	53.0
20.101.24	- 24	38,0	1.1/2"	73.0	58.0
20.101.32	- 32	50,8	2"	77.0	73.0

**MATERIAL:** Carbon Steel

**FINISH:** Chromium-(VI) Free plating / **VERSIONS:** stainless steel AISI 316  
ROHS compliant

**Suitable to be used on medium and high pressure braided hoses:**

FORZA UNO; FORZA UNO "SHARK SKIN"; FORZA UNO "TROPIC"; BALWASH 1W

# NON SKIVE Balfit® 2 Wire Braid Ferrule

20.201. / 20.302.

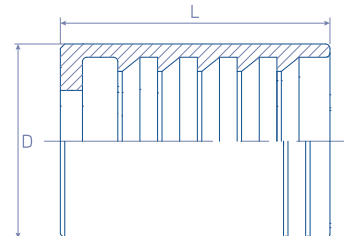

REFERENCE	hose dash	hose Ø		dimensions (mm)	
		mm	inch	L	D
20.201.04	- 4	6,3	1/4"	30.5	22.0
20.201.05	- 5	8,0	5/16"	30.5	21.0
20.201.06	- 6	9,5	3/8"	32.0	25.0
20.302.16	- 16	25,4	1"	50.0	48.0
20.201.20	- 20	32,0	1.1/4"	59.0	56.0
20.201.24	- 24	38,0	1.1/2"	70.0	65.0
20.201.32	- 32	50,8	2"	77.0	75.3

**MATERIAL:** Carbon Steel

**FINISH:** Chromium-(VI) Free plating / **VERSIONS:** stainless steel AISI 316  
ROHS compliant

**Suitable to be used on medium and high pressure braided hoses:**

FORZA DUE; FORZA DUE "SHARK SKIN"; FORZA DUE "TROPIC"; TEXMASTER 3; BALWASH 2W;  
IMPACTUS 5K; IMPACTUS 6K;



# NON SKIVE Balfit® 1 & 2 Wire Braid Ferrule

20.202.

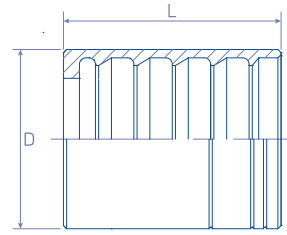

REFERENCE	hose dash	hose Ø		dimensions (mm)	
		mm	inch	L	D
20.202.08	- 8	12,7	1/2"	34.0	28.0
20.202.10	- 10	16,0	5/8"	37.0	32.0
20.202.12	- 12	19,0	3/4"	42.50	36.0

**MATERIAL:** Carbon Steel

**FINISH:** Chromium-(VI) Free plating /  
ROHS compliant

**VERSIONS:** stainless steel AISI 316

**Suitable to be used on medium and high pressure braided hoses:**

FORZA UNO; FORZA UNO "SHARK SKIN"; FORZA UNO "TROPIC"; FORZA DUE; FORZA DUE "SHARK SKIN"; FORZA DUE "TROPIC"; TEXMASTER 3; BALWASH 1W; BALWASH 2W

# NON SKIVE Balfit® 1 Wire Braid Ferrule

20.305.

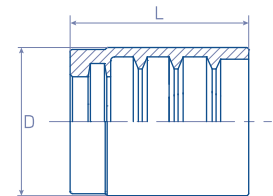

REFERENCE	hose dash	hose Ø		dimensions (mm)	
		mm	inch	L	D
20.305.04	- 4	6,3	1/4"	22.9	19.0
20.305.05	- 5	8,0	5/16"	27.6	20.0
20.305.06	- 6	9,5	3/8"	30.2	23.0
20.305.08	- 8	12,7	1/2"	32.0	26.5
20.305.10	- 10	16,0	5/8"	35.0	29.0
20.305.12	- 12	19,0	3/4"	40.8	33.0
20.305.16	- 16	25,4	1"	45.0	41.9

**MATERIAL:** Carbon Steel

**FINISH:** Chromium-(VI) Free plating /  
ROHS compliant

**VERSIONS:** stainless steel AISI 316

**Suitable to be used on medium and high pressure braided hoses:**

BALPAC 3000; BALPAC 3000 "SHARK SKIN"

# NON SKIVE Balfit® Textile Braid, Thermoplastic & PTFE Ferrule

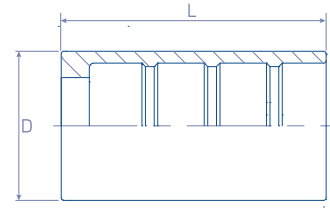

20.107.

REFERENCE	hose dash	hose Ø		dimensions (mm)	
		mm	inch	L	D
20.107.02	- 2	3,2	1/8"	24.1	13.0
20.107.03	- 3	4,8	3/16"	25.0	15.0
20.107.04	- 4	6,3	1/4"	29.2	17.0
20.107.05	- 5	8,0	5/16"	31.0	18.0
20.107.06	- 6	9,5	3/8"	31.0	21.0
20.107.08	- 8	12,7	1/2"	34.0	25.3
20.107.10	- 10	16,0	5/8"	37.0	29.0
20.107.12	- 12	19,0	3/4"	43.0	32.0
20.107.16	- 16	25,4	1"	50.5	40.0

**MATERIAL:** Carbon Steel

**FINISH:** Chromium-(VI) Free plating / **VERSIONS:** stainless steel AISI 316  
ROHS compliant

**Suitable to be used on textile braid, thermoplastic and PTFE hoses:**

TEXMASTER 1, TEXMASTER 2; BALFLON SAE 100R14; BALFLON CONVOLUTED; BALFLON CONVOLUTED BLACK CONDUCTIVE; ZETAFLX; ZETAFLX TWIN; ZETAFLX NON CONDUCTIVE; ZETAFLX NON CONDUCTIVE TWIN; ZETAFLX STEEL; ZETAFLX STEEL TWIN; OMEGAFLEX PLUS; OMEGAFLEX PLUS TWIN LINE; OMEGAFLEX PLUS NON CONDUCTIVE; OMEGAFLEX PLUS TWIN NON CONDUCTIVE; ZETAFLX 3000; ZETAFLX 3000 TWIN; ZETAFLX 3000 NON CONDUCTIVE; ZETAFLX 3000 TWIN NON CONDUCTIVE; PAINTSPRAY



# NON SKIVE Balfit® PTFE Convoluted Ferrule

20.TFC.

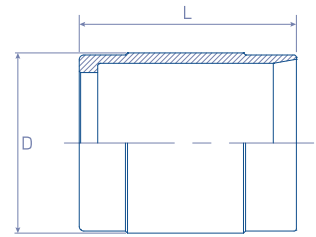

REFERENCE	hose dash	hose Ø		dimensions (mm)	
		mm	inch	L	D
20.TFC.08	- 8	12,7	1/2"	32.0	23.5
20.TFC.12	- 12	19,0	3/4"	43.0	32.0
20.TFC.16	- 16	25,4	1"	47.0	38.1
20.TFC.20	- 20	32,0	1-1/4"	59.0	46.0
20.TFC.24	- 24	38,0	1-1/2"	63.0	55.0
20.TFC.32	- 32	50,8	2"	70.0	69.0

**MATERIAL:** Carbon Steel

**FINISH:** Chromium-(VI) Free plating / **VERSIONS:** stainless steel AISI 316  
ROHS compliant

**Suitable to be used on PTFE hoses:**

BALFLON CONVOLUTED; BALFLON CONVOLUTED BLACK CONDUCTIVE

# NON SKIVE Balfit® 4 Spiral Ferrule

20.NS4.

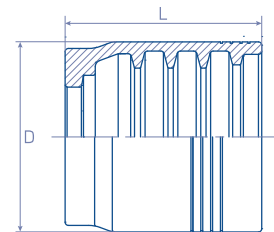

REFERENCE	hose dash	hose Ø		dimensions (mm)	
		mm	inch	L	D
20.NS4.06	- 6	9,5	3/8"	30.0	29.0
20.NS4.08	- 8	12,7	1/2"	33.5	33.0
20.NS4.10	- 10	16,0	5/8"	35.5	37.0
20.NS4.12	- 12	19,0	3/4"	40.0	42.0
20.NS4.16	- 16	25,4	1"	54.0	48.9
20.NS4.20	- 20	32,0	1-1/4"	61.0	61.0
20.NS4.24	- 24	38,0	1-1/2"	71.0	70.0
20.NS4.32	- 32	50,8	2"	88.0	84.8

**MATERIAL:** Carbon Steel

**FINISH:** Chromium-(VI) Free plating / **VERSIONS:** stainless steel AISI 316  
ROHS compliant

**Suitable to be used on high pressure 4 spiral hoses:**

BALMASTER BESTFLEX 4SP; POWERSPIR BESTFLEX 4SH; BALMASTER BESTFLEX R12  
POWERSPIR BESTFLEX R13 (DN20 -3/4" & DN25 - 1"); POWERSPIR BESTFLEX R15  
(DN20 -3/4" & DN25 - 1")

# EXTERNAL SKIVE Balfit® 2 Wire Braid & 4 Spiral Ferrule

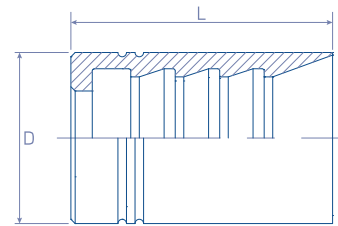

20.200.

REFERENCE	hose dash	hose Ø		dimensions (mm)	
		mm	inch	L	D
20.200.04	- 4	6,3	1/4"	20.0	30.6
20.200.05	- 5	8,0	5/16"	24.0	30.0
20.200.06	- 6	9,5	3/8"	25.0	32.0
20.200.08	- 8	12,7	1/2"	30.0	34.0
20.200.10	- 10	16,0	5/8"	34.0	37.0
20.200.12	- 12	19,0	3/4"	38.0	43.0
20.200.16	- 16	25,4	1"	36.4	50.0
20.200.20	- 20	32,0	1.1/4"	56.0	59.0
20.200.24	- 24	38,0	1.1/2"	62.0	63.1
20.200.32	- 32	50,8	2"	75.1	78.0

**MATERIAL:** Carbon Steel

**FINISH:** Chromium-(VI) Free plating /  
ROHS compliant

**VERSIONS:** stainless steel AISI 316

Suitable to be used on medium and high pressure braided and 4 spiral hoses:

FORZA DUE; FORZA DUE "SHARK SKIN"; FORZA DUE "TROPIC; BALMASTER BESTFLEX 4SP;  
2-MAX; 3-MAX; BALWASH 1W; BALWASH 2W

# DOUBLE SKIVE Balfit® 4 Spiral Ferrule

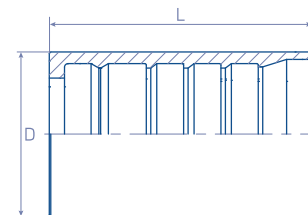

20.405.

REFERENCE	hose dash	hose Ø		dimensions (mm)	
		mm	inch	L	D
20.405.20	- 20	31,8	1.1/4"	88.0	55.0
20.405.24	- 24	38,1	1.1/2"	94.0	62.0
20.405.32	- 32	50,8	2"	99.0	78.0

**MATERIAL:** Carbon Steel

**FINISH:** Chromium-(VI) Free plating /  
ROHS compliant

**VERSIONS:** stainless steel AISI 316

Suitable to be used on high pressure 4 spiral hoses:

POWERSPIR BESTFLEX 4SH



# DOUBLE SKIVE Balfit® 4 & 6 Spiral Ferrule

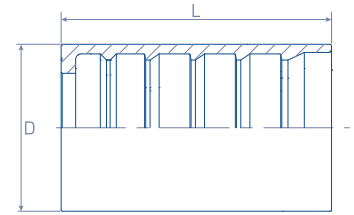

20.406.

REFERENCE	hose	hose Ø		dimensions (mm)	
	dash	mm	inch	L	D
20.406.12	- 12	19,1	3/4"	60.0	38.0
20.406.16	- 16	25,4	1"	74.5	46.0
20.406.20	- 20	31,8	1.1/4"	88.0	60.0
20.406.24	- 24	38,1	1.1/2"	94.0	67.0
20.406.32	- 32	50,8	2"	99.0	84.4

**MATERIAL:** Carbon Steel

**FINISH:** Chromium-(VI) Free plating /  
ROHS compliant

**VERSIONS:** stainless steel AISI 316

**Suitable to be used on high pressure 4 & 6 spiral hoses:**

POWERSPIR BESTFLEX 4SH (DN20 -3/4" & DN25 - 1"); POWERSPIR BESTFLEX R13;  
POWERSPIR BESTFLEX R15



# Standard Hydraulic Fittings

---

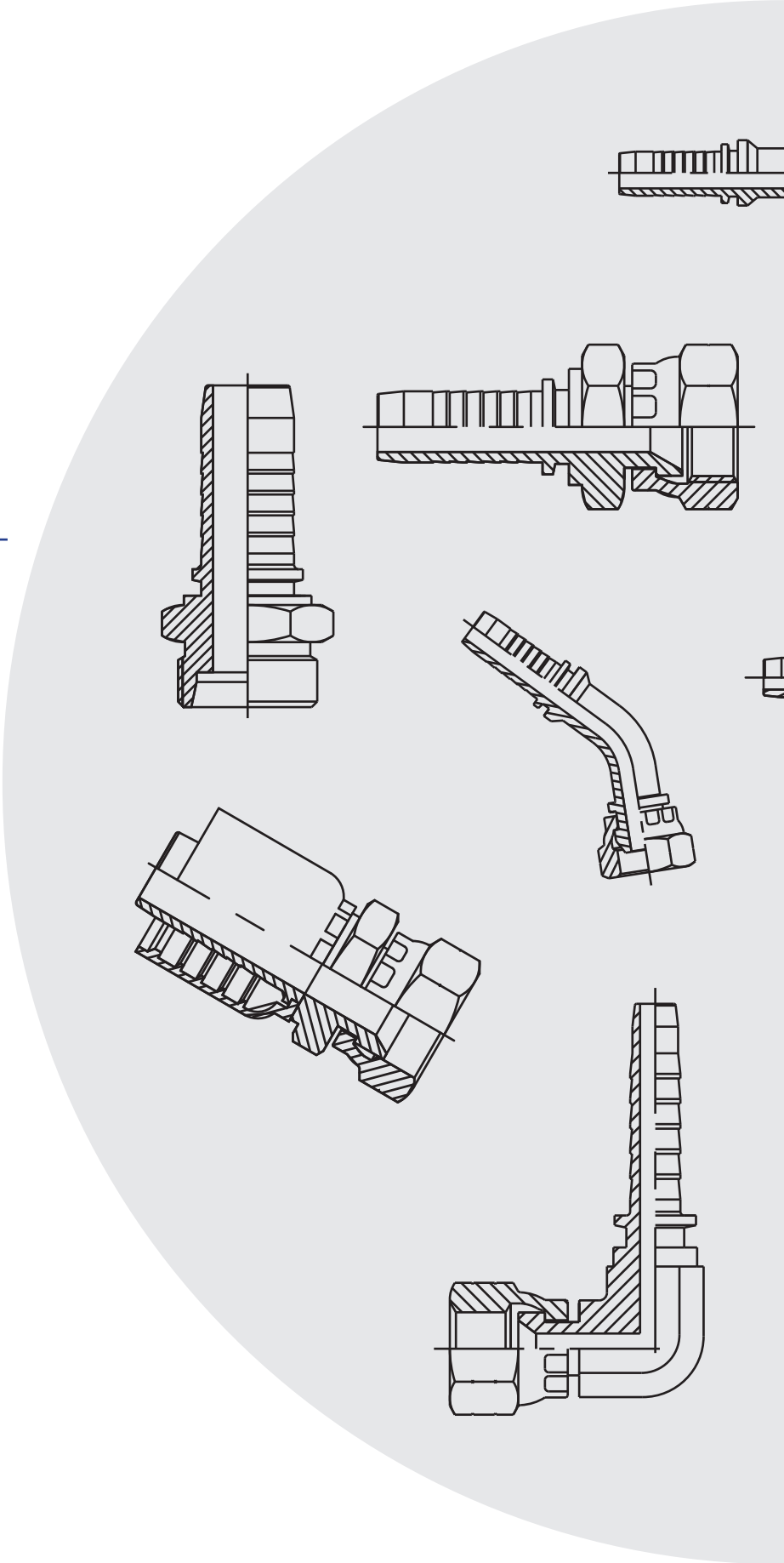

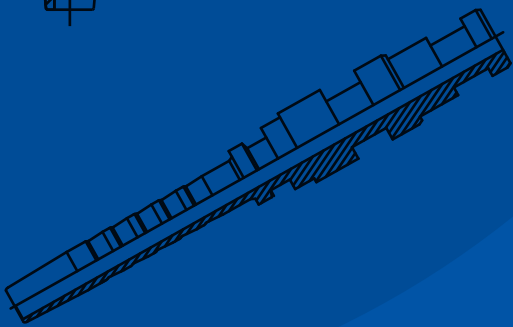
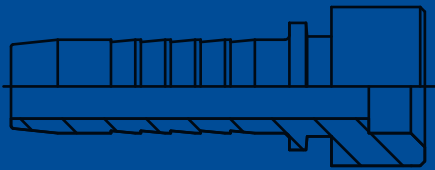
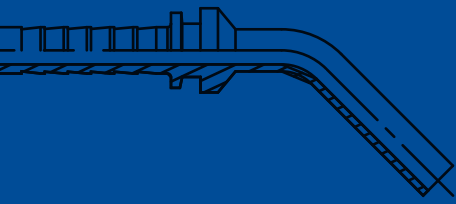
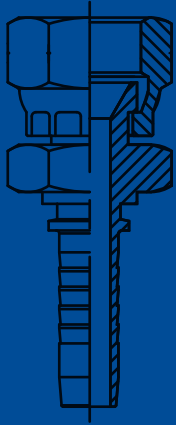

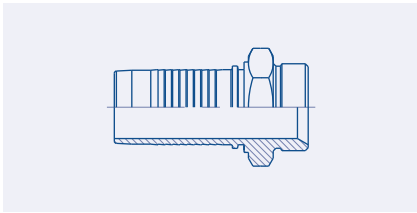

**Male BSP Parallel Pipe (AGR)**  
23.0100

pag. 33

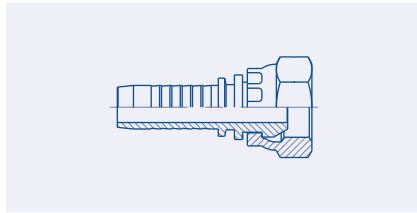

**Female BSP Parallel Pipe Swivel (DKR)**  
23.3012

pag. 34

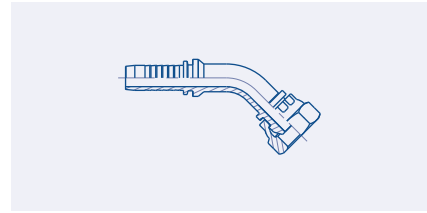

**45° Swept Female BSP Parallel Pipe Swivel (DKR 45°)**  
23.3042

pag. 35

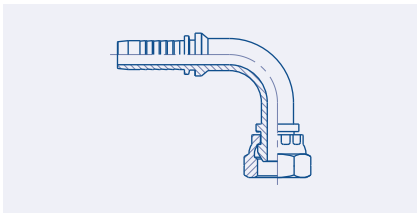

**90° Swept Female BSP Parallel Pipe Swivel (DKR 90°)**  
23.3092

pag. 36

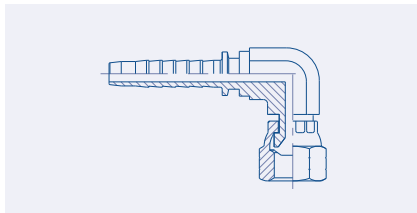

**90° Swept Compact Female BSP Parallel Pipe Swivel**  
23.3082

pag. 37

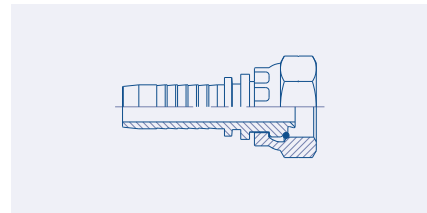

**Female BSP Parallel Pipe with O-ring Swivel (DKOR)**  
23.3112

pag. 37

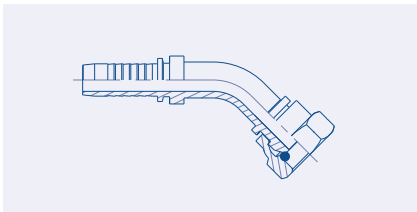

**45° Swept Female BSP Parallel Pipe with O-ring Swivel (DKOR 45°)**  
23.3142

pag. 38

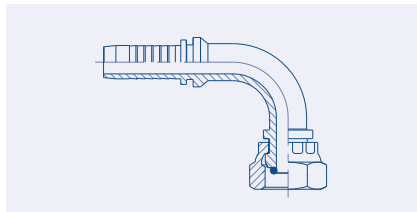

**90° Swept Female BSP Parallel Pipe with O-ring Swivel (DKOR 90°)**  
23.3192

pag. 39

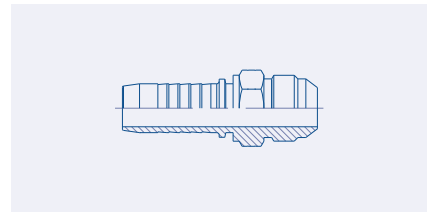

**Male JIC 37° (AGJ)**  
23.2000

pag. 40

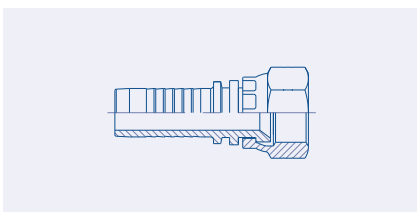

**Female JIC 37° Swivel (DKJ)**  
23.4012

pag. 41

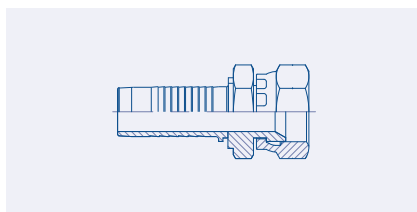

**Female JIC 37° Swivel with Back Hexagon**  
23.4H12

pag. 42

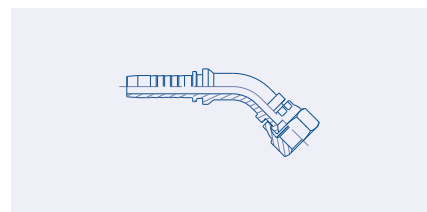

**45° Swept Female JIC 37° Swivel (DKJ 45°)**  
23.4042

pag. 43

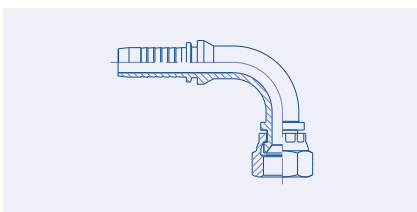

**90° Swept Female JIC 37° Swivel (DKJ 90°)**  
23.4092

pag. 44

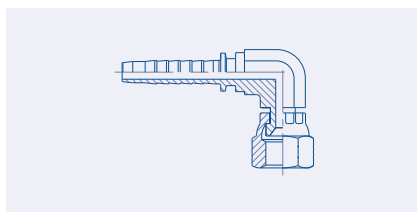

**90° Compact Female JIC 37° Swivel**  
23.4082

pag. 45

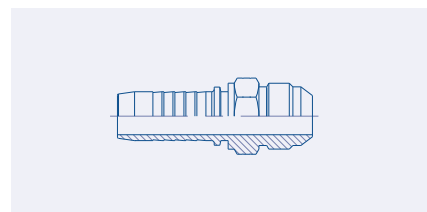

**Male SAE 45°**  
23.2S00

pag. 46

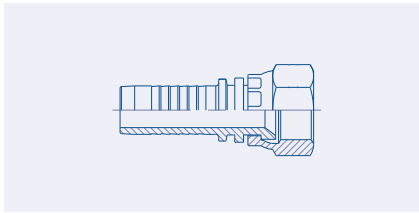

**Female SAE 45° Swivel**  
23.4S12

pag. 46

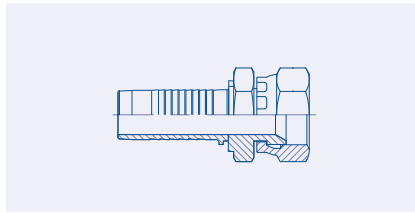

**Female SAE 45° Swivel with Back Hexagon**  
23.SH12

pag. 47

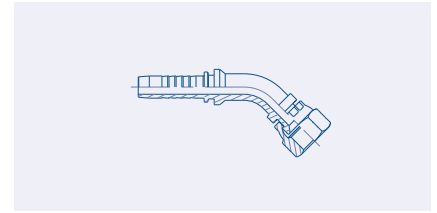

**Female SAE 45° Swivel**  
23.4S42

pag. 47

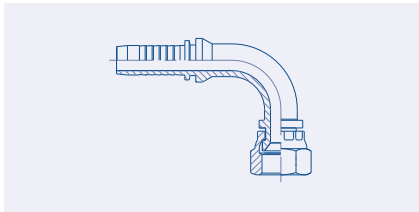

**90° Swept Female SAE 45° Swivel**  
23.4S92

pag. 48

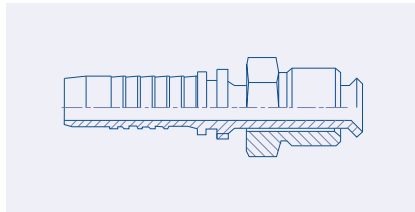

**SAE Inverted 45° Flare Male**  
23.2210

pag. 48

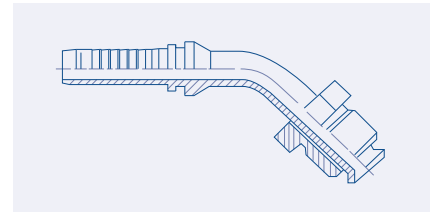

**SAE Inverted 45° Flare 45° Elbow Male**  
23.2240

pag. 49

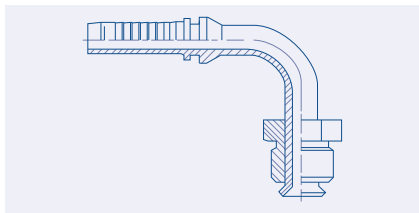

**SAE Inverted 45° Flare 90° Elbow Male**  
23.2290

pag. 49

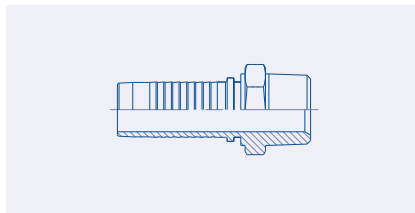

**Male NPTF Pipe (AGN)**  
23.0400

pag. 50

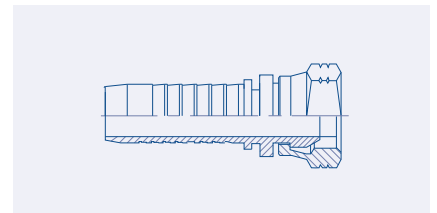

**Female NPSM Pipe Swivel**  
23.3010

pag. 51

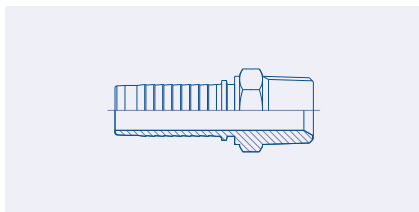

**Male BSPT Taper Pipe (AGR-K)**  
23.0300

pag. 51

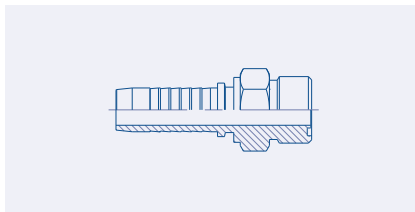

**Male ORFS**  
23.4000

pag. 52

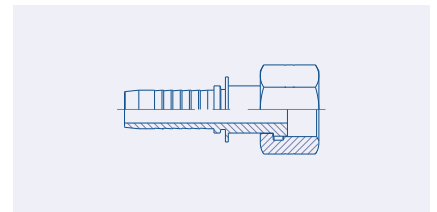

**Female ORFS Swivel**  
23.4414

pag. 53

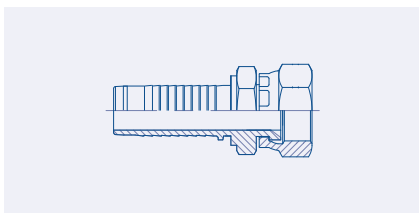

**Female ORFS Swivel with Back Hexagon**  
23.44H4

pag. 54

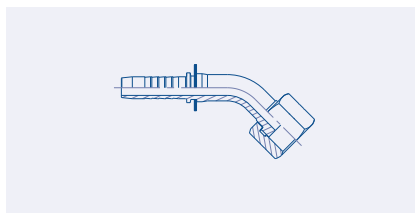

**45° Swept Female ORFS Swivel**  
23.4444

pag. 55

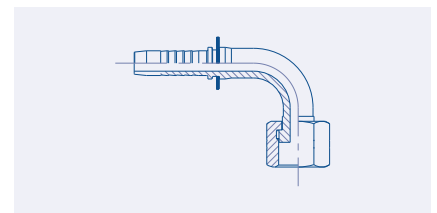

**90° Swept Female ORFS Swivel**  
23.4494

pag. 56

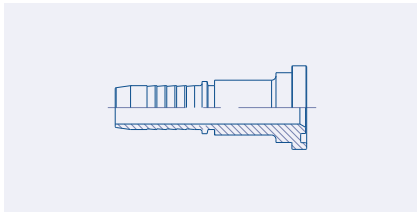

**Straight SAE 3000 PSI  
(code 61) Flange (SFL)**

23.7013

pag. 57

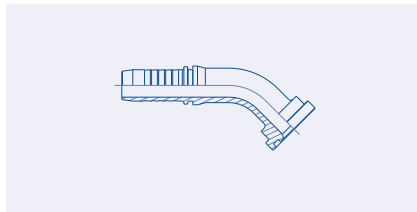

**45° Swept SAE 3000 PSI  
(code 61) Flange (SFL 45°)**

23.7043

pag. 58

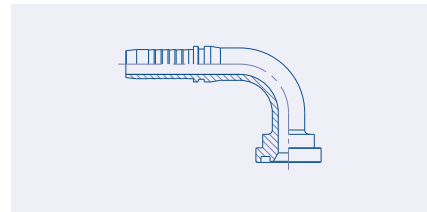

**90° Swept SAE 3000 PSI  
(code 61) Flange (SFL 90°)**

23.7093

pag. 59

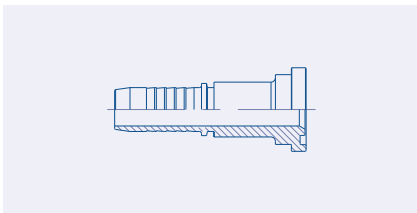

**Straight SAE 6000 PSI  
(code 62) Flange (SFS)**

23.7016

pag. 60

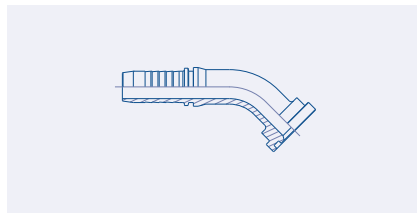

**45° Swept SAE 6000 PSI  
(code 62) Flange (SFS 45°)**

23.7046

pag. 61

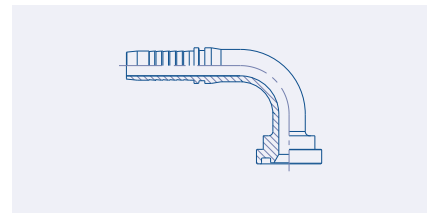

**90° Swept SAE 6000 PSI  
(code 62) Flange (SFS 90°)**

23.7096

pag. 62

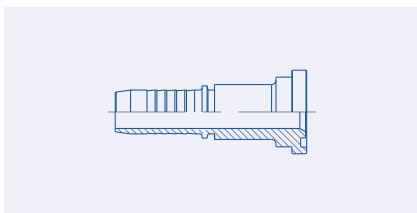

**Straight SUPERCAT Flange**

23.7116

pag. 63

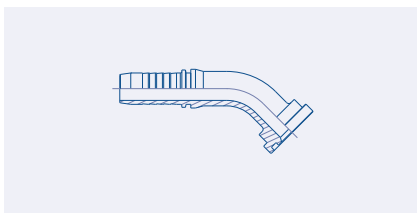

**45° Swept SUPERCAT Flange**

23.7146

pag. 63

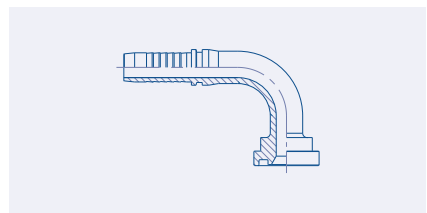

**90° Swept SUPERCAT Flange**

23.7196

pag. 64

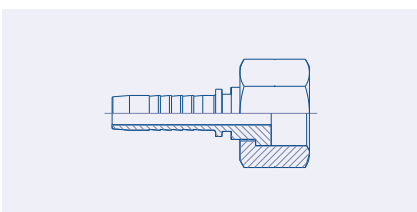

**Female BSP Flat Face Swivel**

23.3212

pag. 65

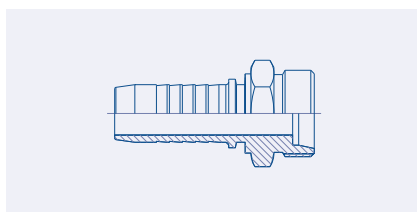

**Male Metric Light Serie 24°  
Cone Seat (CEL)**

23.1000

pag. 66

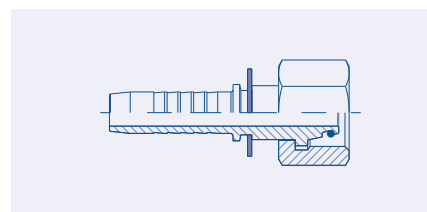

**Female Metric Light Serie 24°  
Cone Seat Swivel (DKOL)**

23.5013

pag. 67

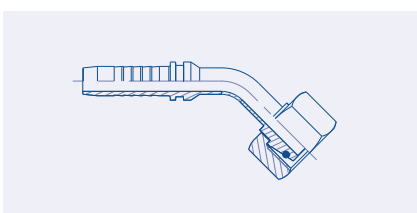

**45° Swept Female Metric Light  
Serie 24° Cone Seat Swivel  
(DKOL 45)**

23.5043

pag. 68

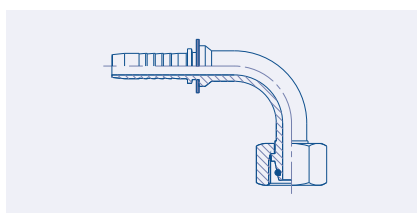

**90° Swept Female Metric Light  
Serie 24° Cone Seat Swivel  
(DKOL 90)**

23.5093

pag. 69

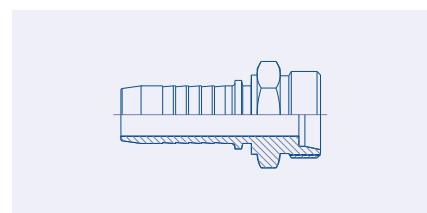

**Male Metric Heavy Serie 24°  
Cone Seat (CES)**

23.1100

pag. 70

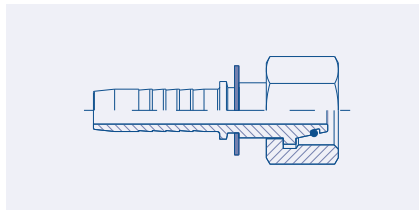

**Female Metric Heavy Serie 24°  
Cone Seat Swivel (DKOS)**  
23.5113 pag. 71

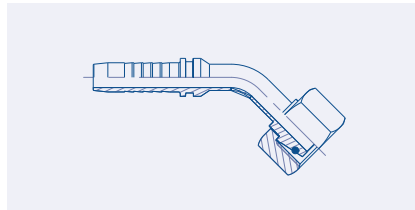

**45° Swept Female Metric Heavy  
Serie 24° Cone Seat Swivel  
(DKOS 45)** 23.5143 pag. 72

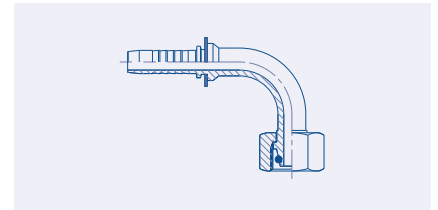

**90° Swept Female Metric Heavy  
Serie 24° Cone Seat Swivel  
(DKOS 90)** 23.5193 pag. 73

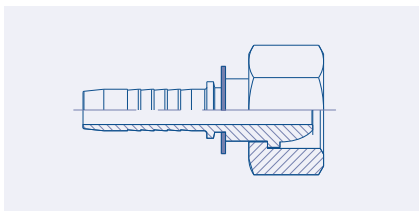

**Female Metric 24°/60°C  
one Seat Swivel (DKL)**  
23.5213 pag. 74

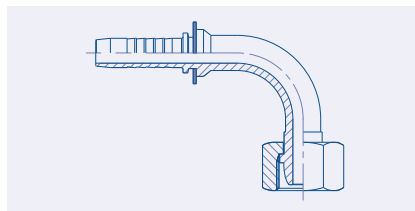

**90° Swept Female Metric 24°/60°C  
Cone Seat Swivel (DKL)**  
23.5293 pag. 74

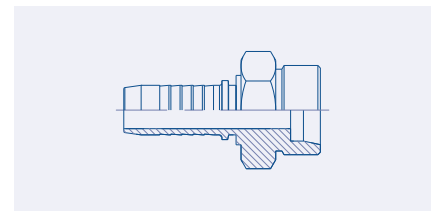

**Male Metric French Serie  
24° Cone Seat (AGF)**  
23.1200 pag. 75

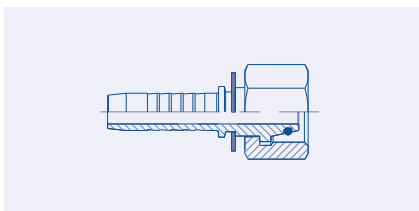

**Female Metric French Serie  
24° Cone Seat Swivel (DKF)**  
23.5513 pag. 75

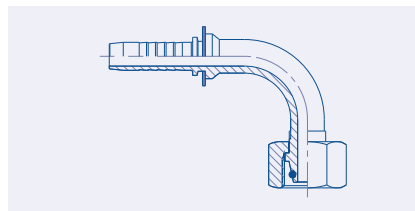

**90° Swept Female Metric French  
Serie 24° Cone Seat Swivel  
(DKF)** 23.5593 pag. 76

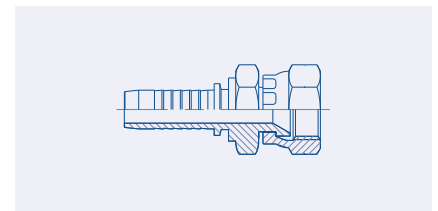

**Female JIS 60° Cone Seat Swivel  
(TOYOTA)**  
23.3712 pag. 76

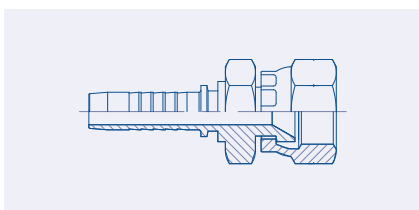

**Female JIS 60° Cone Seat Swivel  
(KOMATSU)**  
23.5911 pag. 77

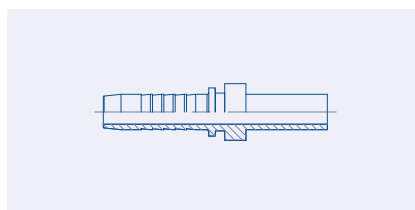

**Metric Standpipe (BEL)**  
23.6000 pag. 78

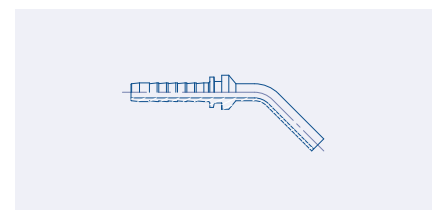

**45° Swept Metric Standpipe  
(BEL 45)**  
23.6040 pag. 79

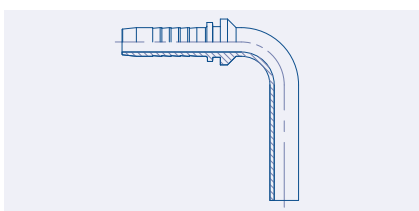

**90° Swept Metric Standpipe  
(BEL 90)**  
23.6090 pag. 80

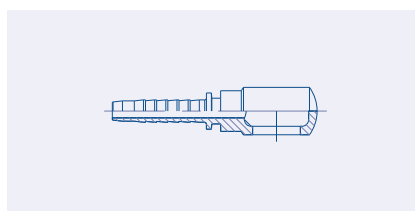

**Metric Banjo (RNM)**  
23.6400 pag. 81

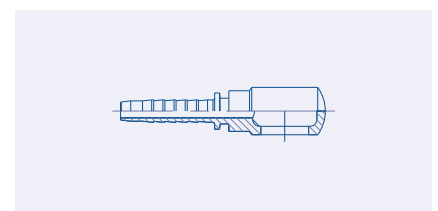

**BSP Banjo (RNR)**  
23.6500 pag. 82



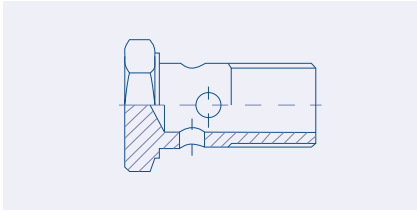

**BSP Banjo Bolt**  
88.1600

pag. 83

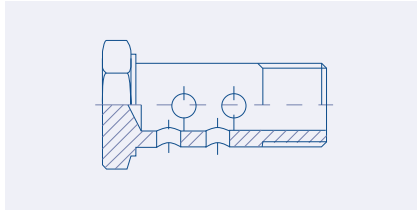

**BSP Banjo Double Bolt**  
88.1602

pag. 83

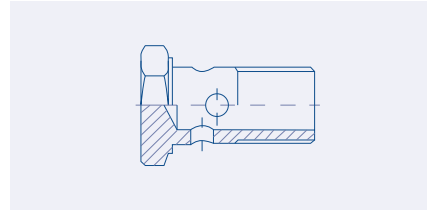

**Metric Banjo Bolt**  
88.1650

pag. 84

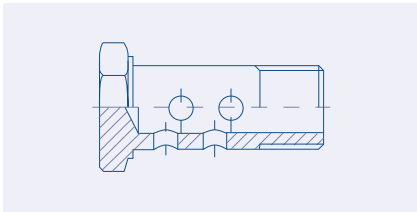

**Metric Banjo Double Bolt**  
88.1652

pag. 84

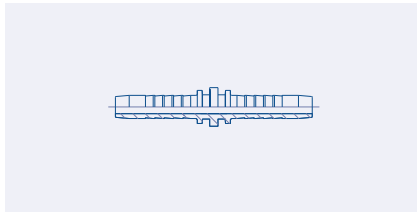

**Hose Connector**  
23.8100

pag. 85

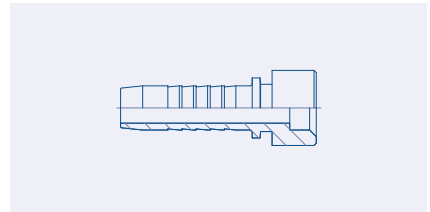

**Brazing Tail**  
23.8150

pag. 85

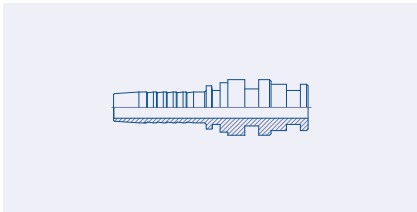

**StapleLock Male**  
23.8300

pag. 86

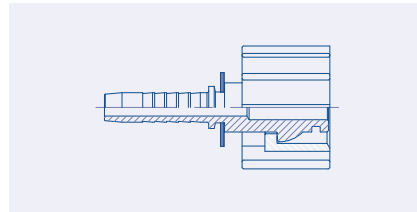

**Balwash Female Swivel (Karcher)**  
23.6213

pag. 86

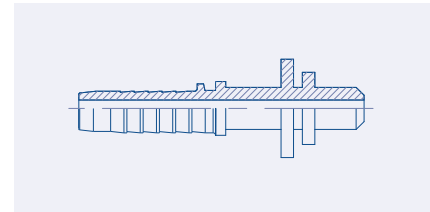

**Balwash Standpipe wit O-ring (Karcher)**  
23.6214

pag. 87



**Balwash Rubber Handle**  
11.800

pag. 87

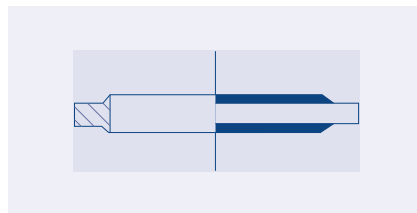

**BSP Bonded Seals**  
88.2003

pag. 88

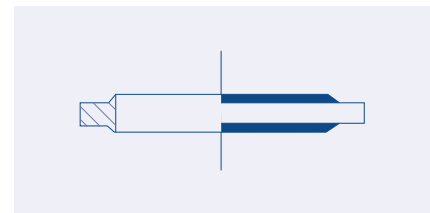

**Metric Bonded Seals**  
88.2004

pag. 88

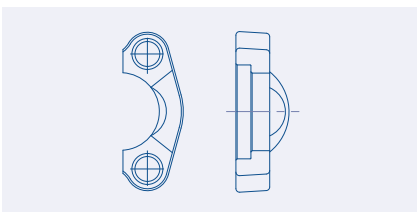

**Split Flange 3000 PSI (code 61)**  
88.5300

pag. 89

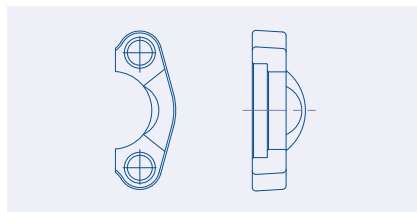

**Split Flange 6000 PSI (code 62)**  
88.5600

pag. 89



# Male BSP Parallel Pipe (AGR)

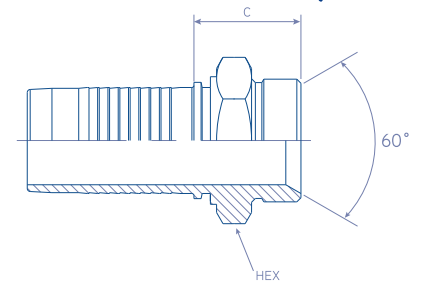

23.0100.

ISO 12151-6 / ISO 8434-6 / BS 5200

REFERENCE	hose dash	hose Ø inch	thread inch	C cut off mm	HEX mm
23.0100.0302	-3	3/16"	1/8" - 28	23.0	14
23.0100.0304	-3	3/16"	1/4" - 19	27.0	19
23.0100.0402	-4	1/4"	1/8" - 28	22.2	14
23.0100.0404	-4	1/4"	1/4" - 19	26.2	19
23.0100.0406	-4	1/4"	3/8" - 19	28.7	22
23.0100.0408	-4	1/4"	1/2" - 14	33.2	27
23.0100.0504	-5	5/16"	1/4" - 19	26.5	19
23.0100.0506	-5	5/16"	3/8" - 19	29.0	22
23.0100.0508	-5	5/16"	1/2" - 14	33.5	27
23.0100.0604	-6	3/8"	1/4" - 19	26.5	19
23.0100.0606	-6	3/8"	3/8" - 19	29.0	22
23.0100.0608	-6	3/8"	1/2" - 14	33.5	27
23.0100.0806	-8	1/2"	3/8" - 19	29.5	22
23.0100.0808	-8	1/2"	1/2" - 14	33.5	27
23.0100.0810	-8	1/2"	5/8" - 14	36.5	30
23.0100.0812	-8	1/2"	3/4" - 14	39.5	32
23.0100.1008	-10	5/8"	1/2" - 14	34.5	27
23.0100.1010	-10	5/8"	5/8" - 14	36.0	30
23.0100.1012	-10	5/8"	3/4" - 14	39.5	32
23.0100.1212	-12	3/4"	3/4" - 14	39.2	32
23.0100.1216	-12	3/4"	1" - 11	44.2	41
23.0100.1616	-16	1"	1" - 11	45.0	41
23.0100.1620	-16	1"	1 1/4" - 11	48.0	50
23.0100.2020	-20	1 1/4"	1 1/4" - 11	49.5	50
23.0100.2024	-20	1 1/4"	1 1/2" - 11	52.0	55
23.0100.2424	-24	1 1/2"	1 1/2" - 11	52.0	55
23.0100.2432	-24	1 1/2"	2" - 11	57.5	70
23.0100.3232	-32	2"	2" - 11	57.5	70

**MATERIAL:** Carbon Steel

**FINISH:** Chromium-(VI) Free plating /  
ROHS compliant

**VERSIONS:** Stainless Steel (add an 'S'  
at the end of the REFERENCE)

# Female BSP Parallel Pipe Swivel (DKR)

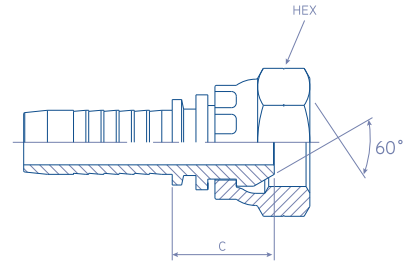

23.3012.

ISO 12151-6 / ISO 8434-6 / BS 5200

REFERENCE	hose dash	hose Ø inch	thread inch	C cut off mm	HEX mm
23.3012.0302	-3	3/16"	1/8" - 28	16.0	14
23.3012.0304	-3	3/16"	1/4" - 19	18.5	19
23.3012.0402	-4	1/4"	1/8" - 28	15.2	14
23.3012.0404	-4	1/4"	1/4" - 19	17.7	19
23.3012.0406	-4	1/4"	3/8" - 19	18.7	22
23.3012.0408	-4	1/4"	1/2" - 14	20.7	27
23.3012.0504	-5	5/16"	1/4" - 19	18.0	19
23.3012.0506	-5	5/16"	3/8" - 19	19.5	22
23.3012.0508	-5	5/16"	1/2" - 14	21.0	27
23.3012.0604	-6	3/8"	1/4" - 19	18.0	19
23.3012.0606	-6	3/8"	3/8" - 19	19.5	22
23.3012.0608	-6	3/8"	1/2" - 14	21.0	27
23.3012.0806	-8	1/2"	3/8" - 19	19.5	22
23.3012.0808	-8	1/2"	1/2" - 14	21.5	27
23.3012.0810	-8	1/2"	5/8" - 14	22.0	30
23.3012.0812	-8	1/2"	3/4" - 14	21.0	27
23.3012.1008	-10	5/8"	1/2" - 14	22.5	27
23.3012.1010	-10	5/8"	5/8" - 14	23.0	30
23.3012.1012	-10	5/8"	3/4" - 14	23.5	32
23.3012.1212	-12	3/4"	3/4" - 14	23.7	32
23.3012.1216	-12	3/4"	1" - 11	22.7	38
23.3012.1616	-16	1"	1" - 11	26.5	38
23.3012.1620	-16	1"	1.1/4" - 11	29.0	50
23.3012.2020	-20	1.1/4"	1.1/4" - 11	30.5	50
23.3012.2024	-20	1.1/4"	1.1/2" - 11	30.0	55
23.3012.2424	-24	1.1/2"	1.1/2" - 11	32.0	55
23.3012.2432	-24	1.1/2"	2" - 11	34.0	70
23.3012.3232	-32	2"	2" - 11	34.0	70
23.3012.4040	-40	2.1/2"	2.1/2" - 11	41.0	90
23.3012.4848	-48	3"	3" - 11	47.0	100

**MATERIAL:** Carbon Steel

**FINISH:** Chromium-(VI) Free plating / ROHS compliant

**VERSIONS:** Stainless Steel (add an 'S' at the end of the REFERENCE)

**NOTES:** On larger sizes nuts can be supplied with Trust-Wire Nut (W)



# 45° Swept Female BSP Parallel Pipe Swivel (DKR 45°)

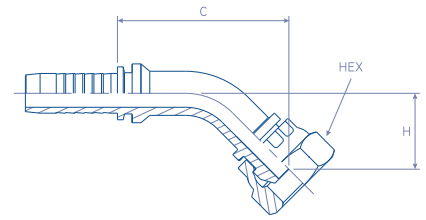

23.3042.

ISO 12151-6 / ISO 8434-6 / BS 5200

REFERENCE	hose dash	hose Ø inch	thread inch	C cut off mm	H mm	HEX mm
23.3042.0302	-3	3/16"	1/8" - 28	30.0	12.5	14
23.3042.0304	-3	3/16"	1/4" - 19	33.5	13.0	19
23.3042.0402	-4	1/4"	1/8" - 28	29.0	12.5	14
23.3042.0404	-4	1/4"	1/4" - 19	33.5	13.0	19
23.3042.0406	-4	1/4"	3/8" - 19	34.2	14.4	22
23.3042.0408	-4	1/4"	1/2" - 14	38.0	16.0	27
23.3042.0504	-5	5/16"	1/4" - 19	33.5	13.0	19
23.3042.0506	-5	5/16"	3/8" - 19	42.5	19.0	22
23.3042.0508	-5	5/16"	1/2" - 14	42.5	19.0	27
23.3042.0604	-6	3/8"	1/4" - 19	33.5	13.0	19
23.3042.0606	-6	3/8"	3/8" - 19	40.0	14.7	22
23.3042.0608	-6	3/8"	1/2" - 14	38.6	15.8	27
23.3042.0806	-8	1/2"	3/8" - 19	34.2	15.0	22
23.3042.0808	-8	1/2"	1/2" - 14	46.0	18.0	27
23.3042.0810	-8	1/2"	5/8" - 14	55.0	23.0	27
23.3042.0812	-8	1/2"	3/4" - 14	56.0	24.0	32
23.3042.1008	-10	5/8"	1/2" - 14	46.5	18.0	27
23.3042.1010	-10	5/8"	5/8" - 14	60.5	23.3	27
23.3042.1012	-10	5/8"	3/4" - 14	64.0	26.9	32
23.3042.1212	-12	3/4"	3/4" - 14	67.5	24.5	32
23.3042.1216	-12	3/4"	1" - 11	70.0	26.0	38
23.3042.1616	-16	1"	1" - 11	83.6	33.8	38
23.3042.1620	-16	1"	1.1/4" - 11	92.3	41.7	50
23.3042.2020	-20	1.1/4"	1.1/4" - 11	97.0	37.5	50
23.3042.2024	-20	1.1/4"	1.1/2" - 11	102.0	42.0	55
23.3042.2424	-24	1.1/2"	1.1/2" - 11	119.0	49.2	55
23.3042.2432	-24	1.1/2"	2" - 11	125.0	55.0	70
23.3042.3232	-32	2"	2" - 11	149.8	60.0	70

**MATERIAL:** Carbon Steel  
**FINISH:** Chromium-(VI) Free plating /  
ROHS compliant

**VERSIONS:** Stainless Steel (add an 'S'  
at the end of the REFERENCE)

**NOTES:** On larger sizes nuts can be  
supplied with Trust-Wire Nut (W)

# 90° Swept Female BSP Parallel Pipe Swivel (DKR 90°)

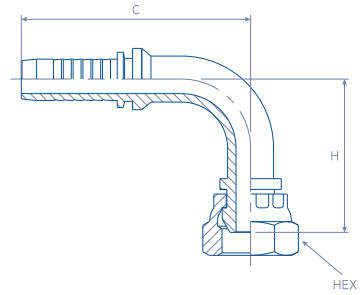

23.3092.

ISO 12151-6 / ISO 8434-6 / BS 5200

REFERENCE	hose dash	hose Ø inch	thread inch	C cut off mm	H mm	HEX mm
23.3092.0302	-3	3/16"	1/8" - 28	25.5	26.0	14
23.3092.0304	-3	3/16"	1/4" - 19	25.5	26.0	19
23.3092.0402	-4	1/4"	1/8" - 28	26.7	26.5	14
23.3092.0404	-4	1/4"	1/4" - 19	27.6	27,5	19
23.3092.0406	-4	1/4"	3/8" - 19	28.0	29,5	22
23.3092.0408	-4	1/4"	1/2" - 14	30.0	30.0	27
23.3092.0504	-5	5/16"	1/4" - 19	32.0	30.0	19
23.3092.0506	-5	5/16"	3/8" - 19	32.5	30.5	22
23.3092.0508	-5	5/16"	1/2" - 14	30.0	30.0	27
23.3092.0604	-6	3/8"	1/4" - 19	28.0	29,5	19
23.3092.0606	-6	3/8"	3/8" - 19	33.0	31,5	22
23.3092.0608	-6	3/8"	1/2" - 14	34.0	31,5	27
23.3092.0806	-8	1/2"	3/8" - 19	35.0	35.0	22
23.3092.0808	-8	1/2"	1/2" - 14	39,5	38,5	27
23.3092.0810	-8	1/2"	5/8" - 14	45.0	42.0	27
23.3092.0812	-8	1/2"	3/4" - 14	54.0	55.0	32
23.3092.1008	-10	5/8"	1/2" - 14	54.0	48.0	27
23.3092.1010	-10	5/8"	5/8" - 14	54.0	50.0	27
23.3092.1012	-10	5/8"	3/4" - 14	54.0	55.0	32
23.3092.1212	-12	3/4"	3/4" - 14	55,5	55.0	32
23.3092.1216	-12	3/4"	1" - 11	60,5	64.0	38
23.3092.1616	-16	1"	1" - 11	71,5	71.0	38
23.3092.1620	-16	1"	1.1/4" - 11	79,5	79,5	50
23.3092.2020	-20	1.1/4"	1.1/4" - 11	85,5	77.0	50
23.3092.2024	-20	1.1/4"	1.1/2" - 11	91,5	92.0	55
23.3092.2424	-24	1.1/2"	1.1/2" - 11	102.0	100.0	55
23.3092.2432	-24	1.1/2"	2" - 11	110.0	110.0	70
23.3092.3232	-32	2"	2" - 11	132.3	128.0	70

**MATERIAL:** Carbon Steel  
**FINISH:** Chromium-(VI) Free plating / ROHS compliant

**VERSIONS:** Stainless Steel (add an 'S' at the end of the REFERENCE)

**NOTES:** On larger sizes nuts can be supplied with Trust-Wire Nut (W)



# 90° Swept Compact Female BSP Parallel Pipe Swivel

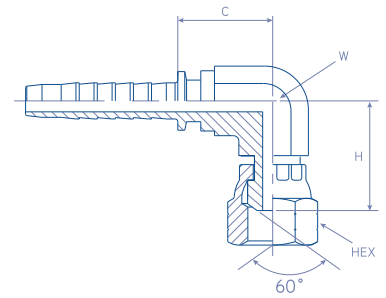

23.3082.

ISO 12151-6 / ISO 8434-6 / BS 5200

	hose	hose Ø	thread	C cut off	H	W	HEX
REFERENCE	dash	inch	inch	mm	mm	mm	mm
23.3082.0404	-4	1/4"	1/4" - 19	17.5	23.5	11	19
23.3082.0606	-6	3/8"	3/8" - 19	21.5	25.5	16	22
23.3082.0808	-8	1/2"	1/2" - 14	25.5	28.0	19	27
23.3082.1010	-10	5/8"	5/8" - 14	22.5	27.0	22	30
23.3082.1212	-12	3/4"	3/4" - 14	26.5	36.0	27	32
23.3082.1616	-16	1"	1" - 11	30.5	34.5	33	38

**MATERIAL:** Carbon Steel

**FINISH:** Chromium-(VI) Free plating /  
ROHS compliant

**VERSIONS:** Stainless Steel (add an 'S'  
at the end of the REFERENCE)

# Female BSP Parallel Pipe with O-ring Swivel (DKOR)

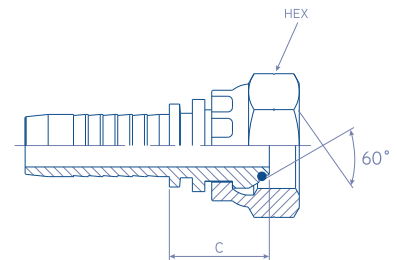

23.3112.

ISO 12151-6 / ISO 8434-6 / BS 5200

	hose	hose Ø	thread	C cut off	HEX
REFERENCE	dash	inch	inch	mm	mm
23.3112.0404	-4	1/4"	1/4" - 19	17.7	19
23.3112.0606	-6	3/8"	3/8" - 19	19.5	22
23.3112.0808	-8	1/2"	1/2" - 14	21.5	27
23.3112.1010	-10	5/8"	5/8" - 14	23.0	30
23.3112.1212	-12	3/4"	3/4" - 14	23.7	32
23.3112.1216	-12	3/4"	1" - 11	22.7	38
23.3112.1616	-16	1"	1" - 11	26.5	38
23.3112.1620	-16	1"	1 1/4" - 11	29.0	50
23.3112.2020	-20	1 1/4"	1 1/4" - 11	30.5	50
23.3112.2024	-20	1 1/4"	1 1/2" - 11	30.0	55
23.3112.2424	-24	1 1/2"	1 1/2" - 11	32.0	55
23.3112.2432	-24	1 1/2"	2" - 11	34.0	70
23.3112.3232	-32	2"	2" - 11	34.0	70

**MATERIAL:** Carbon Steel

**FINISH:** Chromium-(VI) Free plating /  
ROHS compliant

**VERSIONS:** Stainless Steel (add an 'S'  
at the end of the REFERENCE)

**NOTES:** On larger sizes nuts can be  
supplied with Trust-Wire Nut (W)

# 45° Swept Female BSP Parallel Pipe with O-ring Swivel (DKOR 45°)

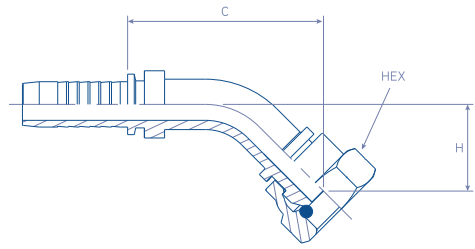

23.3142.

ISO 12151-6 / ISO 8434-6 / BS 5200

REFERENCE	hose dash	hose Ø inch	thread inch	C cut off mm	H mm	HEX mm
23.3142.0404	-4	1/4"	1/4" - 19	33.5	13.0	19
23.3142.0606	-6	3/8"	3/8" - 19	40.0	14.7	22
23.3142.0808	-8	1/2"	1/2" - 14	46.0	18.0	27
23.3142.1010	-10	5/8"	5/8" - 14	60.5	23.3	27
23.3142.1212	-12	3/4"	3/4" - 14	67.5	24.5	32
23.3142.1216	-12	3/4"	1" - 11	70.0	26.0	38
23.3142.1616	-16	1"	1" - 11	83.6	33.8	38
23.3142.1620	-16	1"	1 1/4" - 11	92.3	41.7	50
23.3142.2020	-20	1 1/4"	1 1/4" - 11	97.0	37.5	50
23.3142.2024	-20	1 1/4"	1 1/2" - 11	102.0	42.0	55
23.3142.2424	-24	1 1/2"	1 1/2" - 11	119.0	49.2	55
23.3142.2432	-24	1 1/2"	2" - 11	125.0	55.0	70
23.3142.3232	-32	2"	2" - 11	149.8	60.0	70

**MATERIAL:** Carbon Steel

**FINISH:** Chromium-(VI) Free plating / ROHS compliant

**VERSIONS:** Stainless Steel (add an 'S' at the end of the REFERENCE)

**NOTES:** On larger sizes nuts can be supplied with Trust-Wire Nut (W)



# 90° Swept Female BSP Parallel Pipe with O-ring Swivel (DKOR 90°)

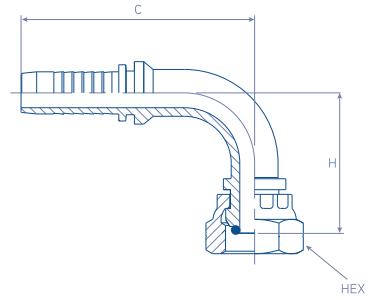

23.3192.

ISO 12151-6 / ISO 8434-6 / BS 5200

	hose	hose Ø	thread	C cut off	H	HEX
REFERENCE	dash	inch	inch	mm	mm	mm
23.3192.0404	-4	1/4"	1/4" - 19	27.6	27,5	19
23.3192.0606	-6	3/8"	3/8" - 19	33.0	31.5	22
23.3192.0808	-8	1/2"	1/2" - 14	39.5	38.5	27
23.3192.1010	-10	5/8"	5/8" - 14	54.0	50.0	27
23.3192.1212	-12	3/4"	3/4" - 14	55.5	55.0	32
23.3192.1216	-12	3/4"	1" - 11	60.5	64.0	38
23.3192.1616	-16	1"	1" - 11	71.5	71.0	38
23.3192.1620	-16	1"	1 1/4" - 11	79.5	79,5	50
23.3192.2020	-20	1 1/4"	1 1/4" - 11	85.5	77.0	50
23.3192.2024	-20	1 1/4"	1 1/2" - 11	91.5	92.0	55
23.3192.2424	-24	1 1/2"	1 1/2" - 11	102.0	100.0	55
23.3192.2432	-24	1 1/2"	2" - 11	110.0	110.0	70
23.3192.3232	-32	2"	2" - 11	132.3	128.0	70

**MATERIAL:** Carbon Steel

**FINISH:** Chromium-(VI) Free plating / ROHS compliant

**VERSIONS:** Stainless Steel (add an 'S' at the end of the REFERENCE)

**NOTES:** On larger sizes nuts can be supplied with Trust-Wire Nut (W)



# Male JIC 37° (AGJ)

23.2000.

ISO 12151-5 / ISO 8434-2 / SAE J516 / SAE J514

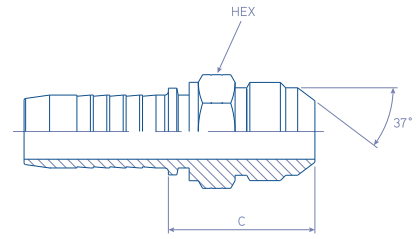

REFERENCE	hose dash	hose Ø inch	thread inch	C cut off mm	HEX mm
23.2000.0304	-3	3/16"	7/16" - 20	26.5	12
23.2000.0404	-4	1/4"	7/16" - 20	25.7	12
23.2000.0405	-4	1/4"	1/2" - 20	26.2	14
23.2000.0406	-4	1/4"	9/16" - 18	26.2	17
23.2000.0505	-5	5/16"	1/2" - 20	26.5	14
23.2000.0506	-5	5/16"	9/16" - 18	27.1	17
23.2000.0606	-6	3/8"	9/16" - 18	27.1	17
23.2000.0608	-6	3/8"	3/4" - 16	30.7	19
23.2000.0610	-6	3/8"	7/8" - 14	35.3	24
23.2000.0808	-8	1/2"	3/4" - 16	31.2	19
23.2000.0810	-8	1/2"	7/8" - 14	35.8	24
23.2000.0812	-8	1/2"	1.1/16" - 12	39.4	27
23.2000.1008	-10	5/8"	3/4" - 16	33.7	24
23.2000.1010	-10	5/8"	7/8" - 14	37.3	24
23.2000.1012	-10	5/8"	1.1/16" - 12	40.9	27
23.2000.1210	-12	3/4"	7/8" - 14	37.5	27
23.2000.1212	-12	3/4"	1.1/16" - 12	40.6	27
23.2000.1214	-12	3/4"	1.3/16" - 12	43.3	32
23.2000.1216	-12	3/4"	1.5/16" - 12	46.0	36
23.2000.1616	-16	1"	1.5/16" - 12	46.8	36
23.2000.1620	-16	1"	1.5/8" - 12	49.0	46
23.2000.2020	-20	1.1/4"	1.5/8" - 12	52.3	46
23.2000.2024	-20	1.1/4"	1.7/8" - 12	55.0	50
23.2000.2424	-24	1.1/2"	1.7/8" - 12	55.0	50
23.2000.2432	-24	1.1/2"	2.1/2" - 12	65.9	65
23.2000.3232	-32	2"	2.1/2" - 12	65.9	65

**MATERIAL:** Carbon Steel

**FINISH:** Chromium-(VI) Free plating / ROHS compliant

**VERSIONS:** Stainless Steel (add an 'S' at the end of the REFERENCE)

# Female JIC 37° Swivel (DKJ)

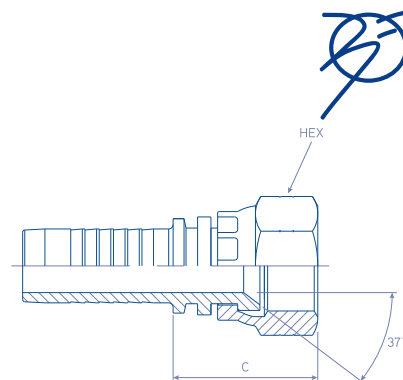

23.4012.

ISO 12151-5 / ISO 8434-2 / SAE J516 / SAE J514

REFERENCE	hose dash	hose Ø inch	thread inch	C cut off mm	HEX mm
23.4012.0304	-3	3/16"	7/16" - 20	15.0	14
23.4012.0404	-4	1/4"	7/16" - 20	14.7	14
23.4012.0405	-4	1/4"	1/2" - 20	15.2	17
23.4012.0406	-4	1/4"	9/16" - 18	15.2	19
23.4012.0505	-5	5/16"	1/2" - 20	15.5	17
23.4012.0506	-5	5/16"	9/16" - 18	15.5	19
23.4012.0606	-6	3/8"	9/16" - 18	15.5	19
23.4012.0608	-6	3/8"	3/4" - 16	17.5	22
23.4012.0610	-6	3/8"	7/8" - 14	18.5	27
23.4012.0806	-8	1/2"	9/16" - 18	16.0	19
23.4012.0808	-8	1/2"	3/4" - 16	18.5	22
23.4012.0810	-8	1/2"	7/8" - 14	19.0	27
23.4012.0812	-8	1/2"	1.1/16" - 12	20.5	32
23.4012.1008	-10	5/8"	3/4" - 16	19.0	22
23.4012.1010	-10	5/8"	7/8" - 14	19.5	27
23.4012.1012	-10	5/8"	1.1/16" - 12	21.0	32
23.4012.1210	-12	3/4"	7/8" - 14	19.7	27
23.4012.1212	-12	3/4"	1.1/16" - 12	21.2	32
23.4012.1214	-12	3/4"	1.3/16" - 12	21.2	38
23.4012.1216	-12	3/4"	1.5/16" - 12	21.7	38
23.4012.1612	-16	1"	1.1/16" - 12	22.5	32
23.4012.1616	-16	1"	1.5/16" - 12	22.5	38
23.4012.1620	-16	1"	1.5/8" - 12	23.5	50
23.4012.2020	-20	1.1/4"	1.5/8" - 12	25.0	50
23.4012.2024	-20	1.1/4"	1.7/8" - 12	26.0	57
23.4012.2424	-24	1.1/2"	1.7/8" - 12	26.0	57
23.4012.2432	-24	1.1/2"	2.1/2" - 12	30.5	75
23.4012.3232	-32	2"	2.1/2" - 12	31.5	75

**MATERIAL:** Carbon Steel

**FINISH:** Chromium-(VI) Free plating /  
ROHS compliant

**VERSIONS:** Stainless Steel (add an 'S'  
at the end of the REFERENCE)

**NOTES:** On larger sizes nuts can  
be supplied with Trust-Wire Nut (W)

# Female JIC 37° Swivel with Back Hexagon

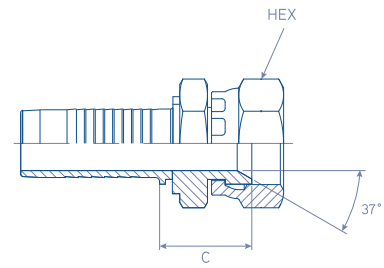

23.4H12.

ISO 12151-5 / ISO 8434-2 / SAE J516 / SAE J514

REFERENCE	hose dash	hose Ø inch	thread inch	C cut off mm	W mm	HEX mm
23.4H12.0304	-3	3/16"	7/16" - 20	21.5	12	14
23.4H12.0404	-4	1/4"	7/16" - 20	20.7	14	14
23.4H12.0405	-4	1/4"	1/2" - 20	20.7	14	16
23.4H12.0406	-4	1/4"	9/16" - 18	22.7	14	19
23.4H12.0506	-5	5/16"	9/16" - 18	22.7	14	19
23.4H12.0606	-6	3/8"	9/16" - 18	21.0	17	19
23.4H12.0608	-6	3/8"	3/4" - 16	26.3	19	22
23.4H12.0610	-6	3/8"	7/8" - 14	28.0	22	27
23.4H12.0808	-8	1/2"	3/4" - 16	26.0	22	22
23.4H12.0810	-8	1/2"	7/8" - 14	29.0	22	27
23.4H12.0812	-8	1/2"	1.1/16" - 12	33.0	25	32
23.4H12.1010	-10	5/8"	7/8" - 14	28.5	22	27
23.4H12.1012	-10	5/8"	1.1/16" - 12	33.5	27	32
23.4H12.1212	-12	3/4"	1.1/16" - 12	33.7	27	32
23.4H12.1214	-12	3/4"	1.3/16" - 12	35.2	32	38
23.4H12.1216	-12	3/4"	1.5/16" - 12	35.2	32	38
23.4H12.1616	-16	1"	1.5/16" - 12	35.5	32	38
23.4H12.1620	-16	1"	1.5/8" - 12	40.5	42	50
23.4H12.2020	-20	1.1/4"	1.5/8" - 12	42.0	42	50
23.4H12.2424	-24	1.1/2"	1.7/8" - 12	45.0	50	57
23.4H12.3232	-32	2"	2.1/2" - 12	49.0	64	75

**MATERIAL:** Carbon Steel

**FINISH:** Chromium-(VI) Free plating / ROHS compliant

**VERSIONS:** Stainless Steel (add an 'S' at the end of the REFERENCE)



# 45° Swept Female JIC 37° Swivel (DKJ 45°)

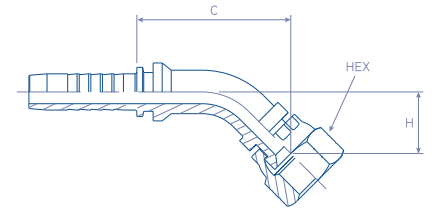

23.4042.

ISO 12151-5 / ISO 8434-2 / SAE J516 / SAE J514

REFERENCE	hose dash	hose Ø inch	thread inch	C cut off mm	H mm	HEX mm
23.4042.0304	-3	3/16"	7/16" - 20	25.0	14.5	14
23.4042.0404	-4	1/4"	7/16" - 20	35.0	14.5	14
23.4042.0405	-4	1/4"	1/2" - 20	35.0	14.5	16
23.4042.0406	-4	1/4"	9/16" - 18	35.0	13.0	19
23.4042.0505	-5	5/16"	1/2" - 20	35.0	14.5	16
23.4042.0506	-5	5/16"	9/16" - 18	38.5	14.5	19
23.4042.0606	-6	3/8"	9/16" - 18	38.5	14.5	19
23.4042.0608	-6	3/8"	3/4" - 16	50.0	15.5	22
23.4042.0610	-6	3/8"	7/8" - 14	40.5	16.5	27
23.4042.0808	-8	1/2"	3/4" - 16	44.4	17.5	22
23.4042.0810	-8	1/2"	7/8" - 14	50.5	21.3	27
23.4042.0812	-8	1/2"	1.1/16" - 12	59.0	25.0	32
23.4042.1010	-10	5/8"	7/8" - 14	52.0	25.0	27
23.4042.1012	-10	5/8"	1.1/16" - 12	64.0	26.5	32
23.4042.1212	-12	3/4"	1.1/16" - 12	67.5	27.0	32
23.4042.1214	-12	3/4"	13/16" - 12	68.0	28.0	38
23.4042.1216	-12	3/4"	1.5/16" - 12	72.0	30.0	38
23.4042.1616	-16	1"	1.5/16" - 12	83.5	32.0	38
23.4042.1620	-16	1"	1.5/8" - 12	83.0	36.0	50
23.4042.2020	-20	1.1/4"	1.5/8" - 12	97.0	37.0	50
23.4042.2424	-24	1.1/2"	1.7/8" - 12	102.0	38.0	57
23.4042.2432	-24	1.1/2"	2.1/2" - 12	119.0	49.2	57
23.4042.3232	-32	2"	2.1/2" - 12	152.0	69.0	75

**MATERIAL:** Carbon Steel

**FINISH:** Chromium-(VI) Free plating / ROHS compliant

**VERSIONS:** Stainless Steel (add an 'S' at the end of the REFERENCE)

**NOTES:** On larger sizes nuts can be supplied with Trust-Wire Nut (W)

# 90° Swept Female JIC 37° Swivel (DKJ 90°)

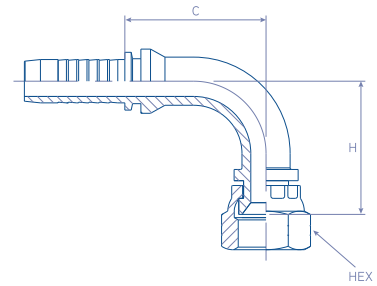

23.4092.

ISO 12151-5 / ISO 8434-2 / SAE J516 / SAE J514

	hose	hose Ø	thread	C cut off	H	HEX
REFERENCE	dash	inch	inch	mm	mm	mm
23.4092.0304	-3	3/16"	7/16" - 20	27.2	29.0	14
23.4092.0404	-4	1/4"	7/16" - 20	30.0	31.0	14
23.4092.0405	-4	1/4"	1/2" - 20	30.8	30.0	16
23.4092.0406	-4	1/4"	9/16" - 18	28.2	28.0	19
23.4092.0505	-5	5/16"	1/2" - 20	32.0	33.0	17
23.4092.0506	-5	5/16"	9/16" - 18	27.0	23.5	19
23.4092.0606	-6	3/8"	9/16" - 18	34.0	30.0	19
23.4092.0608	-6	3/8"	3/4" - 16	35.0	30.0	22
23.4092.0610	-6	3/8"	7/8" - 14	37.1	38.0	27
23.4092.0808	-8	1/2"	3/4" - 16	39.5	38.0	22
23.4092.0810	-8	1/2"	7/8" - 14	36.8	40.5	27
23.4092.0812	-8	1/2"	1.1/16" - 12	46.5	51.0	32
23.4092.1010	-10	5/8"	7/8" - 14	54.0	52.0	27
23.4092.1012	-10	5/8"	1.1/16" - 12	54.0	55.0	32
23.4092.1210	-12	3/4"	7/8" - 14	54.2	55.0	27
23.4092.1212	-12	3/4"	1.1/16" - 12	55.5	55.0	32
23.4092.1214	-12	3/4"	1.3/16" - 12	55.5	57.0	38
23.4092.1216	-12	3/4"	1.5/16" - 12	55.5	60.0	38
23.4092.1616	-16	1"	1.5/16" - 12	71.5	71.0	38
23.4092.1620	-16	1"	1.5/8" - 12	79.5	79.5	50
23.4092.2020	-20	1.1/4"	1.5/8" - 12	85.5	77.0	50
23.4092.2024	-20	1.1/4"	1.7/8" - 12	86.5	90.0	57
23.4092.2424	-24	1.1/2"	1.7/8" - 12	102.0	100.0	57
23.4092.2432	-24	1.1/2"	2.1/2" - 12	118.0	120.0	75
23.4092.3232	-32	2"	2.1/2" - 12	130.5	140.0	75

**MATERIAL:** Carbon Steel  
**FINISH:** Chromium-(VI) Free plating / ROHS compliant

**VERSIONS:** Stainless Steel (add an 'S' at the end of the REFERENCE)

**NOTES:** On larger sizes nuts can be supplied with Trust-Wire Nut (W)



# 90° Compact Female JIC 37° Swivel

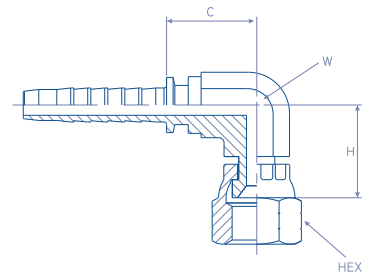

23.4082.

ISO 12151-5 / ISO 8434-2 / SAE J516 / SAE J514

REFERENCE	hose dash	hose Ø inch	thread inch	C cut off mm	H mm	HEX mm
23.4082.0404	-4	1/4"	7/16" - 20	18.5	19.6	14
23.4082.0405	-4	1/4"	1/2" - 20	18.5	21.5	16
23.4082.0406	-4	1/4"	9/16" - 18	18.5	21.8	19
23.4082.0606	-6	3/8"	9/16" - 18	21.5	25.5	19
23.4082.0608	-6	3/8"	3/4" - 16	21.5	26.5	22
23.4082.0808	-8	1/2"	3/4" - 16	25.5	29.5	22
23.4082.0810	-8	1/2"	7/8" - 14	25.5	28	27
23.4082.1212	-12	3/4"	1.1/16" - 12	28.5	30.7	32
23.4082.1616	-16	1"	1.5/16" - 12	30.5	33.5	38

**MATERIAL:** Carbon Steel

**FINISH:** Chromium-(VI) Free plating /  
ROHS compliant

**VERSIONS:** Stainless Steel (add an 'S'  
at the end of the REFERENCE)

# Male SAE 45°

23.2S00.

SAE J512 / SAE J513

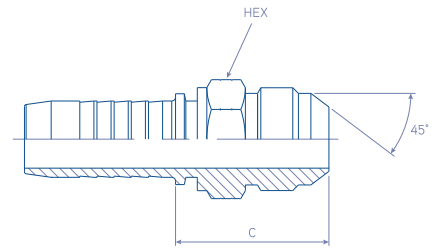

REFERENCE	hose dash	hose Ø inch	thread	C cut off mm	HEX mm
23.2S00.0606	-6	3/8"	5/8" - 18 UNF	27.1	17
23.2S00.1212	-12	3/4"	1.1/16" - 14 UNS	40.6	27

**MATERIAL:** Carbon Steel

**FINISH:** Chromium-(VI) Free plating / ROHS compliant

**VERSIONS:** Stainless Steel (add an 'S' at the end of the REFERENCE)

# Female SAE 45° Swivel

23.4S12.

SAE J512 / SAE J513

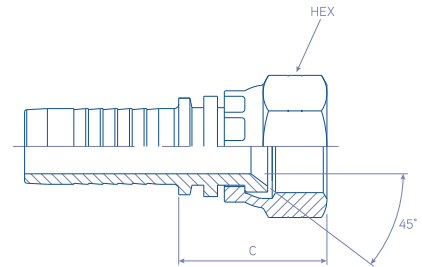

REFERENCE	hose dash	hose Ø inch	thread	C cut off mm	HEX mm
23.4S12.0506	-5	5/16"	5/8" - 18 UNF	17.0	22
23.4S12.0606	-6	3/8"	5/8" - 18 UNF	17.0	22
23.4S12.1212	-12	3/4"	1.1/16" - 14 UNS	21.2	32

**MATERIAL:** Carbon Steel

**FINISH:** Chromium-(VI) Free plating / ROHS compliant

**VERSIONS:** Stainless Steel (add an 'S' at the end of the REFERENCE)

**NOTES:** On larger sizes nuts can be supplied with Trust-Wire Nut (W)



# Female SAE 45° Swivel with Back Hexagon

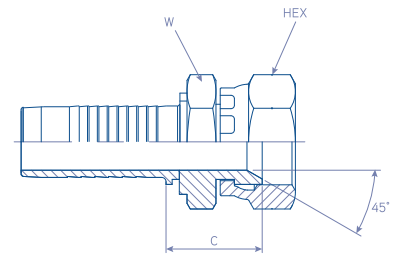

23.SH12.

SAE J512 / SAE J513

	hose	hose Ø	thread	C cut off	W	HEX
REFERENCE	dash	inch		mm	mm	mm
23.SH12.0606	-6	3/8"	5/8" - 18 UNF	26.3	19	22
23.SH12.1212	-12	3/4"	1 1/16" - 14 UNS	33.7	27	32

**MATERIAL:** Carbon Steel

**FINISH:** Chromium-(VI) Free plating / ROHS compliant

**VERSIONS:** Stainless Steel (add an 'S' at the end of the REFERENCE)

# Female SAE 45° Swivel

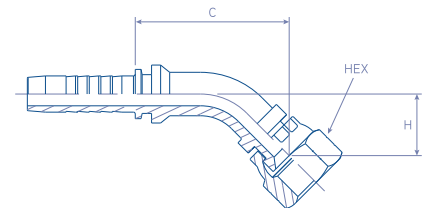

23.4S42.

SAE J512 / SAE J513

	hose	hose Ø	thread	C cut off	H	HEX
REFERENCE	dash	inch		mm	mm	mm
23.4S42.0606	-6	3/8"	5/8" - 18 UNF	39.5	15.5	22
23.4S42.1212	-12	3/4"	1 1/16" - 14 UNS	67.5	27.0	32

**MATERIAL:** Carbon Steel

**FINISH:** Chromium-(VI) Free plating / ROHS compliant

**VERSIONS:** Stainless Steel (add an 'S' at the end of the REFERENCE)

**NOTES:** On larger sizes nuts can be supplied with Trust-Wire Nut (W)



# 90° Swept Female SAE 45° Swivel

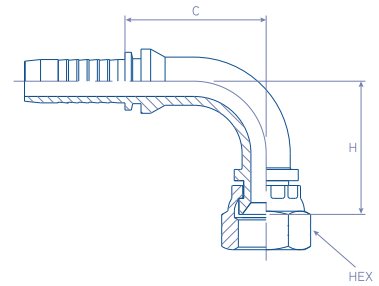

23.4S92.

SAE J512 / SAE J513

REFERENCE	hose dash	hose Ø inch	thread	C cut off mm	H mm	HEX mm
23.4S92.0506	-5	5/16"	5/8" - 18 UNF	32.0	30.0	22
23.4S92.0606	-6	3/8"	5/8" - 18 UNF	34.0	30.0	22
23.4S92.1212	-12	3/4"	1.1/16" - 14 UNS	55.5	55.0	32

**MATERIAL:** Carbon Steel

**FINISH:** Chromium-(VI) Free plating /  
ROHS compliant

**VERSIONS:** Stainless Steel (add an 'S'  
at the end of the REFERENCE)

**NOTES:** On larger sizes nuts can be  
supplied with Trust-Wire Nut (W)

# SAE Inverted 45° Flare Male

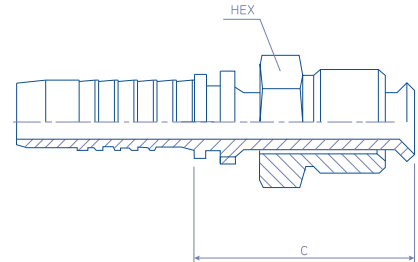

23.2210.

REFERENCE	hose dash	hose Ø inch	thread	C cut off mm	HEX mm
23.2210.0404	04	1/4"	7/16" - 24UNS	42,0	11
23.2210.0405	04	1/4"	1/2" - 20UNF	47,0	13
23.2210.0406	04	1/4"	5/8" - 18UNF	46,0	16
23.2210.0604	04	3/8"	7/16" - 24UNS	42,0	11
23.2210.0605	06	3/8"	1/2" - 20UNF	44,0	13
23.2210.0606	06	3/8"	5/8" - 18UNF	46,0	16
23.2210.0808	08	1/2"	3/4" - 18UNS	47,0	19

**MATERIAL:** Carbon Steel

**FINISH:** Chromium-(VI) Free plating /  
ROHS compliant

**VERSIONS:** Stainless Steel (add an 'S'  
at the end of the REFERENCE)



# SAE Inverted 45° Flare 45° Elbow Male

23.2240.

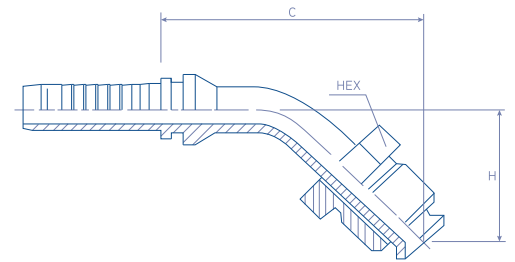

REFERENCE	hose dash	hose Ø inch	thread	C cut off mm	H mm	HEX mm
23.2240.0404	04	1/4"	7/16" - 24UNS	36,0	16,0	11
23.2240.0405	04	1/4"	1/2" - 20UNF	40,0	18,0	13
23.2240.0604	04	3/8"	7/16" - 24UNS	36,0	16,0	11
23.2240.0605	06	3/8"	1/2" - 20UNF	37,0	18,0	13
23.2240.0606	06	3/8"	5/8" - 18UNF	48,0	22,0	16
23.2240.0808	08	1/2"	3/4" - 18UNS	50,0	26,0	19

**MATERIAL:** Carbon Steel

**FINISH:** Chromium-(VI) Free plating /  
ROHS compliant

**VERSIONS:** Stainless Steel (add an 'S'  
at the end of the REFERENCE)

# SAE Inverted 45° Flare 90° Elbow Male

23.2290.

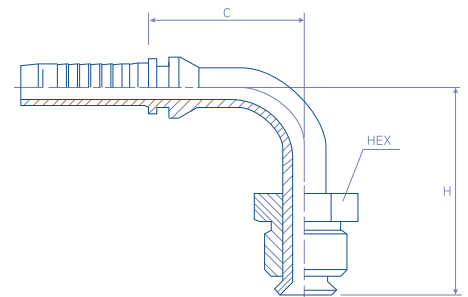

REFERENCE	hose dash	hose Ø inch	thread	C cut off mm	H mm	HEX mm
23.2290.0404	04	1/4"	7/16" - 24UNS	36,0	40,0	11
23.2290.0405	04	1/4"	1/2" - 20UNF	42,0	40,0	13
23.2290.0406	04	1/4"	5/8" - 18UNF	40,0	40,0	16
23.2290.0604	04	3/8"	7/16" - 24UNS	37,0	40,0	11
23.2290.0605	06	3/8"	1/2" - 20UNF	40,0	40,0	13
23.2290.0606	06	3/8"	5/8" - 18UNF	40,0	40,0	16
23.2290.0808	08	1/2"	3/4" - 18UNS	40,0	46,0	19

**MATERIAL:** Carbon Steel

**FINISH:** Chromium-(VI) Free plating /  
ROHS compliant

**VERSIONS:** Stainless Steel (add an 'S'  
at the end of the REFERENCE)

# Male NPTF Pipe (AGN)

23.0400.

SAE J516 / SAE J476A

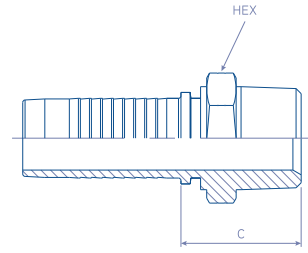

REFERENCE	hose dash	hose Ø inch	thread inch	C cut off mm	HEX mm
23.0400.0302	-3	3/16"	1/8" - 27	22.5	12
23.0400.0304	-3	3/16"	1/4" - 18	28.0	14
23.0400.0402	-4	1/4"	1/8" - 27	21.7	12
23.0400.0404	-4	1/4"	1/4" - 18	27.7	14
23.0400.0406	-4	1/4"	3/8" - 18	28.7	17
23.0400.0408	-4	1/4"	1/2" - 14	34.2	22
23.0400.0504	-5	5/16"	1/4" - 18	28.0	17
23.0400.0506	-5	5/16"	3/8" - 18	30.5	19
23.0400.0604	-6	3/8"	1/4" - 18	28.0	17
23.0400.0606	-6	3/8"	3/8" - 18	30.5	19
23.0400.0608	-6	3/8"	1/2" - 14	34.5	22
23.0400.0806	-8	1/2"	3/8" - 18	31.0	19
23.0400.0808	-8	1/2"	1/2" - 14	35.0	22
23.0400.0812	-8	1/2"	3/4" - 14	37.5	27
23.0400.1008	-10	5/8"	1/2" - 14	36.0	24
23.0400.1012	-10	5/8"	3/4" - 14	39.0	27
23.0400.1208	-12	3/4"	1/2" - 14	38.2	27
23.0400.1212	-12	3/4"	3/4" - 14	38.7	27
23.0400.1216	-12	3/4"	1" - 11.1/2	47.2	36
23.0400.1612	-16	1"	3/4" - 14	41.5	35
23.0400.1616	-16	1"	1" - 11.1/2	48.5	36
23.0400.1620	-16	1"	1.1/4" - 11.1/2	52.0	46
23.0400.2020	-20	1.1/4"	1.1/4" - 11.1/2	53.5	46
23.0400.2024	-20	1.1/4"	1.1/2" - 11.1/2	55.5	50
23.0400.2424	-24	1.1/2"	1.1/2" - 11.1/2	53.0	50
23.0400.2432	-24	1.1/2"	2" - 11.1/2	58.5	65
23.0400.3232	-32	2"	2" - 11.1/2	58.5	65

**MATERIAL:** Carbon Steel

**FINISH:** Chromium-(VI) Free plating / ROHS compliant

**VERSIONS:** Stainless Steel (add an 'S' at the end of the REFERENCE)



# Female NPSM Pipe Swivel

23.3010.

SAE J516 / SAE J514

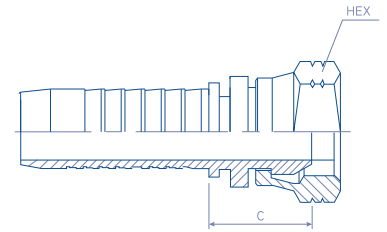

REFERENCE	hose dash	hose Ø inch	thread inch	C cut off mm	HEX mm
23.3010.0402	04	1/4"	1/8"-27	23,7	14
23.3010.0404	04	1/4"	1/4"-18	26,7	19
23.3010.0406	04	1/4"	3/8"-18	29,1	22
23.3010.0606	06	3/8"	3/8"-18	27,2	22
23.3010.0608	06	3/8"	1/2"-14	29,0	27
23.3010.0808	08	1/2"	1/2"-14	30,7	27
23.3010.1212	12	3/4"	3/4"-14	35,3	32
23.3010.1616	16	1"	1"-11.5	38,0	41

**MATERIAL:** Carbon Steel

**FINISH:** Chromium-(VI) Free plating / ROHS compliant

**VERSIONS:** Stainless Steel (add an 'S' at the end of the REFERENCE)

# Male BSPT Taper Pipe (AGR-K)

23.0300.

BS 5200

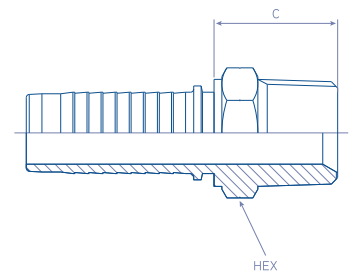

REFERENCE	hose dash	hose Ø inch	thread inch	C cut off mm	HEX mm
23.0300.0302	-3	3/16"	1/8" - 28	22.5	12
23.0300.0304	-3	3/16"	1/4" - 19	27.5	14
23.0300.0402	-4	1/4"	1/8" - 28	21.7	12
23.0300.0404	-4	1/4"	1/4" - 19	26.7	14
23.0300.0406	-4	1/4"	3/8" - 19	27.7	17
23.0300.0606	-6	3/8"	3/8" - 19	30.5	19
23.0300.0608	-6	3/8"	1/2" - 14	34.5	22
23.0300.0808	-8	1/2"	1/2" - 14	35.0	22
23.0300.1212	-12	3/4"	3/4" - 14	38.7	27
23.0300.1616	-16	1"	1" - 14	48.0	36
23.0300.2020	-20	1.1/4"	1.1/4" - 11	53.0	46
23.0300.2424	-24	1.1/2"	1.1/2" - 11	54.5	50
23.0300.3232	-32	2"	2" - 11	61.0	65

**MATERIAL:** Carbon Steel

**FINISH:** Chromium-(VI) Free plating / ROHS compliant

**VERSIONS:** Stainless Steel (add an 'S' at the end of the REFERENCE)

# Male ORFS

23.4000.

ISO 12151-1 / ISO 8434-3 / SAE J516

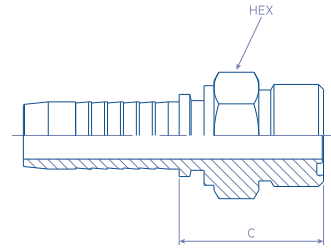

REFERENCE	hose dash	hose Ø inch	thread inch	C cut off mm	HEX mm
23.4000.0404	-4	1/4"	9/16" - 18	22.5	17
23.4000.0406	-4	1/4"	11/16" - 16	24.9	19
23.4000.0506	-5	5/16"	11/16" - 16	25.2	19
23.4000.0606	-6	3/8"	11/16" - 16	25.2	19
23.4000.0608	-6	3/8"	13/16" - 16	28.0	22
23.4000.0808	-8	1/2"	13/16" - 16	28.8	22
23.4000.0810	-8	1/2"	1" - 14	33.0	27
23.4000.0812	-8	1/2"	1.3/16" - 14	37.0	32
23.4000.1010	-10	5/8"	1" - 14	34.0	27
23.4000.1012	-10	5/8"	1.3/16" - 14	37.5	32
23.4000.1212	-12	3/4"	1.3/16" - 14	37.7	32
23.4000.1216	-12	3/4"	1.7/16" - 12	40.7	41
23.4000.1616	-16	1"	1.7/16" - 12	42.5	41
23.4000.2020	-20	1.1/4"	1.11/16" - 12	44.5	46
23.4000.2424	-24	1.1/2"	2" - 12	46.5	55

**MATERIAL:** Carbon Steel

**FINISH:** Chromium-(VI) Free plating / ROHS compliant

**VERSIONS:** Stainless Steel (add an 'S' at the end of the REFERENCE)



# Female ORFS Swivel

23.4414.

ISO 12151-1 / ISO 8434-3 / SAE J516

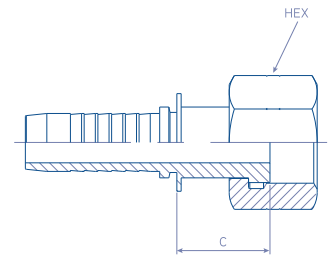

REFERENCE	hose dash	hose Ø inch	thread inch	C cut off mm	HEX mm
23.4414.0404	-4	1/4"	9/16" - 18	20.0	17
23.4414.0406	-4	1/4"	11/16" - 16	23.2	22
23.4414.0506	-5	5/16"	11/16" - 16	23.5	22
23.4414.0606	-6	3/8"	11/16" - 16	24.5	22
23.4414.0608	-6	3/8"	13/16" - 16	25.0	24
23.4414.0808	-8	1/2"	13/16" - 16	26.5	24
23.4414.0810	-8	1/2"	1" - 14	29.5	30
23.4414.0812	-8	1/2"	1.3/16" - 14	30.5	36
23.4414.1008	-10	5/8"	13/16" - 16	29.0	24
23.4414.1010	-10	5/8"	1" - 14	30.9	30
23.4414.1012	-10	5/8"	1.3/16" - 14	30.6	36
23.4414.1210	-12	3/4"	1" - 14	33.2	30
23.4414.1212	-12	3/4"	1.3/16" - 14	31.7	36
23.4414.1216	-12	3/4"	1.7/16" - 12	34.7	41
23.4414.1616	-16	1"	1.7/16" - 12	34.1	41
23.4414.1620	-16	1"	1.11/16" - 12	34.0	50
23.4414.2020	-20	1.1/4"	1.11/16" - 12	36.5	50
23.4414.2024	-20	1.1/4"	2" - 12	36.5	50
23.4414.2424	-24	1.1/2"	2" - 12	36.0	60

**MATERIAL:** Carbon Steel

**FINISH:** Chromium-(VI) Free plating /  
ROHS compliant

**VERSIONS:** Stainless Steel (add an 'S'  
at the end of the REFERENCE)

# Female ORFS Swivel with Back Hexagon

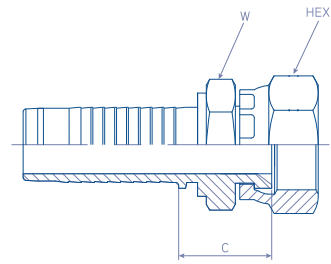

23.44H4.

ISO 12151-1 / ISO 8434-3 / SAE J516

REFERENCE	hose dash	hose Ø inch	thread inch	C cut off mm	W mm	HEX mm
23.44H4.0404	-4	1/4"	9/16" - 18	28.2	14	17
23.44H4.0406	-4	1/4"	11/16" - 16	31.7	17	22
23.44H4.0606	-6	3/8"	11/16" - 16	32.0	17	22
23.44H4.0608	-6	3/8"	13/16" - 16	35.0	19	24
23.44H4.0808	-8	1/2"	13/16" - 16	35.5	19	24
23.44H4.0810	-8	1/2"	1" - 14	41.5	24	30
23.44H4.0812	-8	1/2"	1.3/16" - 14	44.5	30	36
23.44H4.1010	-10	5/8"	1" - 14	42.5	24	30
23.44H4.1012	-10	5/8"	1.3/16" - 14	45.0	28	36
23.44H4.1212	-12	3/4"	1.3/16" - 14	45.6	30	36
23.44H4.1216	-12	3/4"	1.7/16" - 12	50.2	35	41
23.44H4.1616	-16	1"	1.7/16" - 12	50.7	35	41
23.44H4.1620	-16	1"	1.11/16" - 12	52.0	35	50
23.44H4.2020	-20	1.1/4"	1.11/16" - 12	54.5	41	50
23.44H4.2424	-24	1.1/2"	2" - 12	57.0	50	60

**MATERIAL:** Carbon Steel

**FINISH:** Chromium-(VI) Free plating / ROHS compliant

**VERSIONS:** Stainless Steel (add an 'S' at the end of the REFERENCE)



# 45° Swept Female ORFS Swivel

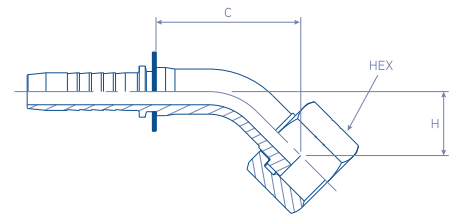

23.4444.

ISO 12151-5 / ISO 8434-2 / SAE J516 / SAE J514

REFERENCE	hose dash	hose Ø inch	thread inch	C cut off mm	H mm	HEX mm
23.4444.0404	-4	1/4"	9/16" - 18	32.5	11.0	17
23.4444.0406	-4	1/4"	11/16" - 16	36.0	13.0	22
23.4444.0506	-5	5/16"	11/16" - 16	39.0	13.0	22
23.4444.0606	-6	3/8"	11/16" - 16	36.0	13.4	22
23.4444.0608	-6	3/8"	13/16" - 16	39.0	15.0	24
23.4444.0808	-8	1/2"	13/16" - 16	43.0	15.0	24
23.4444.0810	-8	1/2"	1" - 14	45.0	17.0	30
23.4444.0812	-8	1/2"	1.3/16" - 14	54.0	21.0	36
23.4444.1008	-10	5/8"	13/16" - 16	54.0	22.0	24
23.4444.1010	-10	5/8"	1" - 14	55.0	21.0	30
23.4444.1012	-10	5/8"	1.3/16" - 14	57.0	23.0	36
23.4444.1210	-12	3/4"	1" - 14	60.0	23.0	30
23.4444.1212	-12	3/4"	1.3/16" - 14	62.0	22.0	36
23.4444.1216	-12	3/4"	1.7/16" - 12	66.0	24.0	41
23.4444.1616	-16	1"	1.7/16" - 12	76.0	27.0	41
23.4444.1620	-16	1"	1.11/16" - 12	76.0	27.0	50
23.4444.2020	-20	1.1/4"	1.11/16" - 12	95.0	34.0	50
23.4444.2424	-24	1.1/2"	2" - 12	120.0	45.0	60

**MATERIAL:** Carbon Steel

**FINISH:** Chromium-(VI) Free plating / ROHS compliant

**VERSIONS:** Stainless Steel (add an 'S' at the end of the REFERENCE)



# 90° Swept Female ORFS Swivel

23.4494.

ISO 12151-5 / ISO 8434-2 / SAE J516 / SAE J514

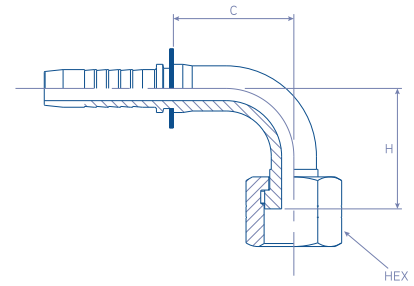

REFERENCE	hose dash	hose Ø inch	thread inch	C cut off mm	H mm	HEX mm
23.4494.0404	-4	1/4"	9/16" - 18	26.0	21.0	17
23.4494.0406	-4	1/4"	11/16" - 16	27.0	25.0	22
23.4494.0506	-5	5/16"	11/16" - 16	33.0	27.5	22
23.4494.0606	-6	3/8"	11/16" - 16	34.5	29.0	22
23.4494.0608	-6	3/8"	13/16" - 16	35.5	30.0	24
23.4494.0808	-8	1/2"	13/16" - 16	40.0	35.0	24
23.4494.0810	-8	1/2"	1" - 14	40.5	36.5	30
23.4494.0812	-8	1/2"	1.3/16" - 14	42.0	43.0	36
23.4494.1008	-10	5/8"	13/16" - 16	42.0	46.0	24
23.4494.1010	-10	5/8"	1" - 14	54.0	50.0	30
23.4494.1012	-10	5/8"	1.3/16" - 14	53.0	48.0	36
23.4494.1210	-12	3/4"	1" - 14	55.0	50.0	30
23.4494.1212	-12	3/4"	1.3/16" - 14	57.0	49.0	36
23.4494.1216	-12	3/4"	1.7/16" - 12	57.0	52.0	41
23.4494.1616	-16	1"	1.7/16" - 12	68.0	59.0	41
23.4494.1620	-16	1"	1.11/16" - 12	68.0	77.0	50
23.4494.2020	-20	1.1/4"	1.11/16" - 12	85.0	77.0	50
23.4494.2424	-24	1.1/2"	2" - 12	98.0	94.0	60

**MATERIAL:** Carbon Steel

**FINISH:** Chromium-(VI) Free plating / ROHS compliant

**VERSIONS:** Stainless Steel (add an 'S' at the end of the REFERENCE)



# Straight SAE 3000 PSI (code 61) Flange (SFL)

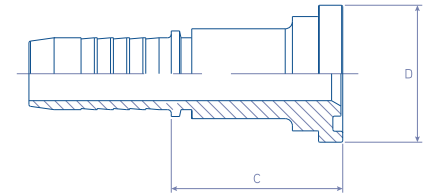

23.7013.

ISO 6162-1 / ISO 12151-3 / SAE J516 / SAE J518

REFERENCE	hose dash	hose Ø inch	D Ø Flange mm	C Cut Off mm
23.7013.0808	-8	1/2"	30.2	40.0
23.7013.0812	-8	1/2"	38.1	42.0
23.7013.1010	-10	5/8"	34.0	37.0
23.7013.1012	-10	5/8"	38.1	45.0
23.7013.1212	-12	3/4"	38.1	45.0
23.7013.1216	-12	3/4"	44.5	48.0
23.7013.1616	-16	1"	44.5	50.0
23.7013.1620	-16	1"	50.8	54.0
23.7013.2020	-20	1 1/4"	50.8	55.0
23.7013.2024	-20	1 1/4"	60.3	60.0
23.7013.2424	-24	1 1/2"	60.3	60.0
23.7013.2432	-24	1 1/2"	71.4	65.0
23.7013.3232	-32	2"	71.4	66.0
23.7013.4040	-40	2 1/2"	84.1	90.0
23.7013.4848	-48	3"	101.6	91.0

**MATERIAL:** Carbon Steel

**FINISH:** Chromium-(VI) Free plating /  
ROHS compliant

**VERSIONS:** Stainless Steel (add an 'S'  
at the end of the REFERENCE)

**NOTES:** Although not in the SAE  
or the ISO standard the size 34.0mm  
(5/8) is according to JIS standard

# 45° Swept SAE 3000 PSI (code 61) Flange (SFL 45°)

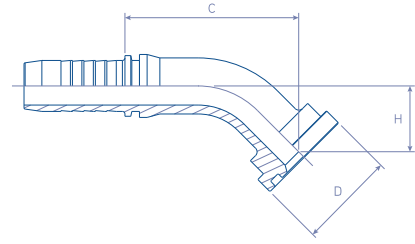

23.7043.

ISO 6162-1 / ISO 12151-3 / SAE J516 / SAE J518

	hose	hose Ø	D Ø flange	C cut off	H
REFERENCE	dash	inch	mm	mm	mm
23.7043.0808	-8	1/2"	30.2	57.0	23.0
23.7043.0812	-8	1/2"	38.1	63.0	28.0
23.7043.1010	-10	5/8"	34.0	67.0	28.0
23.7043.1012	-10	5/8"	38.1	68.0	28.0
23.7043.1212	-12	3/4"	38.1	69.0	28.0
23.7043.1216	-12	3/4"	44.5	75.0	32.0
23.7043.1616	-16	1"	44.5	76.0	31.0
23.7043.1620	-16	1"	50.8	85.0	35.0
23.7043.2020	-20	1.1/4"	50.8	95.0	36.0
23.7043.2024	-20	1.1/4"	60.3	100.0	38.0
23.7043.2424	-24	1.1/2"	60.3	100.0	40.0
23.7043.2432	-24	1.1/2"	71.4	110.0	42.0
23.7043.3232	-32	2"	71.4	145.0	56.0
23.7043.4040	-40	2.1/2"	84.1	135.0	58.0
23.7043.4848	-48	3"	101.6	136.0	58.0

**MATERIAL:** Carbon Steel

**FINISH:** Chromium-(VI) Free plating /  
ROHS compliant

**VERSIONS:** Stainless Steel (add an 'S'  
at the end of the REFERENCE)

**NOTES:** Although not in the SAE  
or the ISO standard the size 34.0mm  
(5/8) is according to JIS standard



# 90° Swept SAE 3000 PSI (code 61) Flange (SFL 90°)

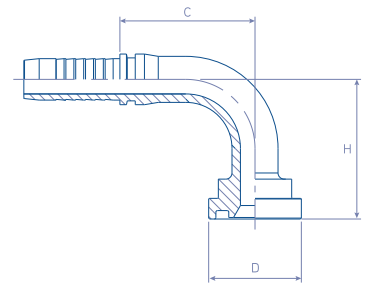

23.7093.

ISO 6162-1 / ISO 12151-3 / SAE J516 / SAE J518

REFERENCE	hose dash	hose Ø inch	D Ø flange mm	C cut off mm	H mm
23.7093.0808	-8	1/2"	30.2	46.5	45.0
23.7093.0812	-8	1/2"	38.1	49.0	49.5
23.7093.1010	-10	5/8"	34.0	55.5	55.0
23.7093.1012	-10	5/8"	38.1	55.5	56.5
23.7093.1212	-12	3/4"	38.1	55.5	58.0
23.7093.1216	-12	3/4"	44.5	70.0	61.0
23.7093.1616	-16	1"	44.5	69.9	61.0
23.7093.1620	-16	1"	50.8	88.0	83.0
23.7093.2020	-20	1.1/4"	50.8	88.0	93.0
23.7093.2024	-20	1.1/4"	60.3	95.0	98.0
23.7093.2424	-24	1.1/2"	60.3	100.0	110.0
23.7093.2432	-24	1.1/2"	71.4	130.0	110.0
23.7093.3232	-32	2"	71.4	136.2	125.0
23.7093.4040	-40	2.1/2"	84.1	132.7	114.2
23.7093.4848	-48	3"	101.6	60.5	55.0

**MATERIAL:** Carbon Steel

**FINISH:** Chromium-(VI) Free plating /  
ROHS compliant

**VERSIONS:** Stainless Steel (add an 'S'  
at the end of the REFERENCE)

**NOTES:** Although not in the SAE  
or the ISO standard the size 34.0mm  
(5/8) is according to JIS standard

# Straight SAE 6000 PSI (code 62) Flange (SFS)

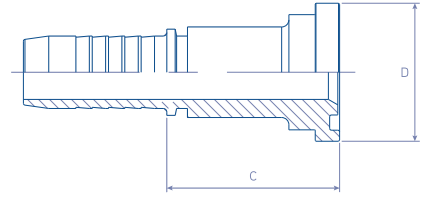

23.7016.

ISO 6162-2 / ISO 12151-3 / SAE J516 / SAE J518

REFERENCE	hose dash	hose Ø inch	D Ø flange mm	C cut off mm
23.7016.0808	-8	1/2"	31.8	46.0
23.7016.0812	-8	1/2"	31.8	46.0
23.7016.1012	-10	5/8"	41.3	46.0
23.7016.1212	-12	3/4"	41.3	46.0
23.7016.1216	-12	3/4"	47.6	56.0
23.7016.1616	-16	1"	47.6	57.0
23.7016.1620	-16	1"	54.0	65.0
23.7016.2020	-20	1.1/4"	54.0	66.0
23.7016.2024	-20	1.1/4"	63.5	75.0
23.7016.2424	-24	1.1/2"	63.5	75.0
23.7016.2432	-24	1.1/2"	79.4	80.0
23.7016.3232	-32	2"	79.4	85.0

**MATERIAL:** Carbon Steel

**FINISH:** Chromium-(VI) Free plating /  
ROHS compliant

**VERSIONS:** Stainless Steel (add an 'S'  
at the end of the REFERENCE)



# 45° Swept SAE 6000 PSI (code 62) Flange (SFS 45°)

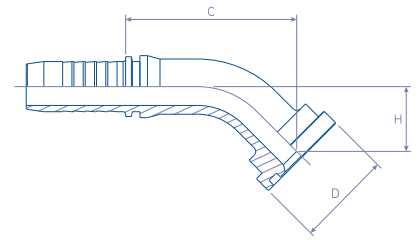

23.7046.

ISO 6162-1 / ISO 12151-3 / SAE J516 / SAE J518

REFERENCE	hose dash	hose Ø inch	D Ø flange mm	C cut off mm	H mm
23.7046.0808	-8	1/2"	31.8	57.0	23.0
23.7046.0812	-8	1/2"	31.8	63.0	30.0
23.7046.1012	-10	5/8"	41.3	68.0	28.0
23.7046.1212	-12	3/4"	41.3	69.0	28.0
23.7046.1216	-12	3/4"	47.6	77.0	33.0
23.7046.1616	-16	1"	47.6	79.0	32.0
23.7046.1620	-16	1"	54.0	93.0	38.0
23.7046.2020	-20	1.1/4"	54.0	110.0	44.0
23.7046.2024	-20	1.1/4"	63.5	112.0	48.0
23.7046.2424	-24	1.1/2"	63.5	110.0	46.0
23.7046.2432	-24	1.1/2"	79.4	134.0	58.0
23.7046.3232	-32	2"	79.4	155.0	64.0

**MATERIAL:** Carbon Steel

**FINISH:** Chromium-(VI) Free plating /  
ROHS compliant

**VERSIONS:** Stainless Steel (add an 'S'  
at the end of the REFERENCE)

# 90° Swept SAE 6000 PSI (code 62) Flange (SFS 90°)

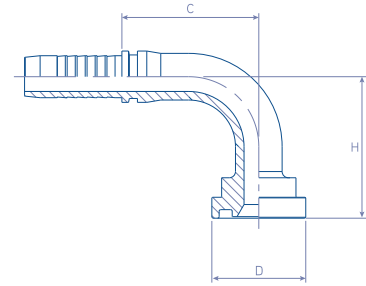

23.7096.

ISO 6162-1 / ISO 12151-3 / SAE J516 / SAE J518

REFERENCE	hose dash	hose Ø inch	D Ø flange mm	C cut off mm	H mm
23.7096.0808	-8	1/2"	31.8	46.5	47.0
23.7096.0812	-8	1/2"	31.8	50.5	56.0
23.7096.1012	-10	5/8"	41.3	53.5	58.0
23.7096.1212	-12	3/4"	41.3	55.5	56.5
23.7096.1216	-12	3/4"	47.6	55.5	65.0
23.7096.1616	-16	1"	47.6	76.0	66.0
23.7096.1620	-16	1"	54.0	78.5	79.5
23.7096.2020	-20	1.1/4"	54.0	101.7	86.0
23.7096.2024	-20	1.1/4"	63.5	102.3	98.0
23.7096.2424	-24	1.1/2"	63.5	111.0	104.0
23.7096.2432	-24	1.1/2"	79.4	113.0	119.5
23.7096.3232	-32	2"	79.4	149.3	134.0

**MATERIAL:** Carbon Steel

**FINISH:** Chromium-(VI) Free plating / ROHS compliant

**VERSIONS:** Stainless Steel (add an 'S' at the end of the REFERENCE)



# Straight SUPERCAT Flange

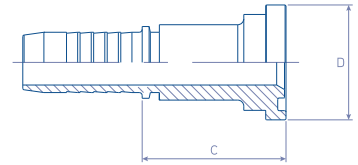

23.7116.

ISO 6162-2 / ISO 12151-3 / SAE J516 / SAE J518

REFERENCE	hose dash	hose Ø inch	D Ø flange mm	C cut off mm
23.7116.0808	-8	1/2"	31.8	46.0
23.7116.0812	-8	1/2"	31.8	46.0
23.7116.1012	-10	5/8"	41.3	46.0
23.7116.1212	-12	3/4"	41.3	46.0
23.7116.1216	-12	3/4"	47.6	56.0
23.7116.1616	-16	1"	47.6	57.0
23.7116.1620	-16	1"	54.0	65.0
23.7116.2020	-20	1.1/4"	54.0	66.0
23.7116.2024	-20	1.1/4"	63.5	75.0
23.7116.2424	-24	1.1/2"	63.5	75.0
23.7116.2432	-24	1.1/2"	79.4	80.0
23.7116.3232	-32	2"	79.4	85.0

**MATERIAL:** Carbon Steel

**FINISH:** Chromium-(VI) Free plating / ROHS compliant

**VERSIONS:** Stainless Steel (add an 'S' at the end of the REFERENCE)

# 45° Swept SUPERCAT Flange

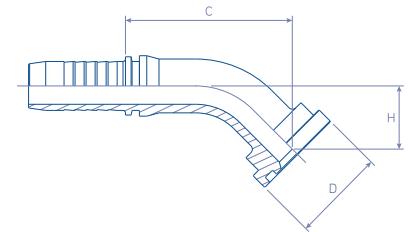

23.7146.

ISO 6162-1 / ISO 12151-3 / SAE J516 / SAE J518

REFERENCE	hose dash	hose Ø inch	D Ø flange mm	C cut off mm	H mm
23.7146.0808	-8	1/2"	31.8	57.0	23.0
23.7146.0812	-8	1/2"	31.8	63.0	30.0
23.7146.1012	-10	5/8"	41.3	68.0	28.0
23.7146.1212	-12	3/4"	41.3	69.0	28.0
23.7146.1216	-12	3/4"	47.6	77.0	33.0
23.7146.1616	-16	1"	47.6	79.0	32.0
23.7146.1620	-16	1"	54.0	93.0	38.0
23.7146.2020	-20	1.1/4"	54.0	110.0	44.0
23.7146.2024	-20	1.1/4"	63.5	112.0	48.0
23.7146.2424	-24	1.1/2"	63.5	110.0	46.0
23.7146.2432	-24	1.1/2"	79.4	134.0	58.0
23.7146.3232	-32	2"	79.4	155.0	64.0

**MATERIAL:** Carbon Steel

**FINISH:** Chromium-(VI) Free plating / ROHS compliant

**VERSIONS:** Stainless Steel (add an 'S' at the end of the REFERENCE)



# 90° Swept SUPERCAT Flange

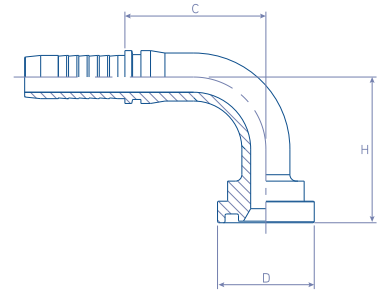

23.7196.

ISO 6162-1 / ISO 12151-3 / SAE J516 / SAE J518

REFERENCE	hose dash	hose Ø inch	D Ø flange mm	C cut off mm	H mm
23.7196.0808	-8	1/2"	31.8	46.5	47.0
23.7196.0812	-8	1/2"	31.8	50.5	56.0
23.7196.1012	-10	5/8"	41.3	53.5	58.0
23.7196.1212	-12	3/4"	41.3	55.5	56.5
23.7196.1216	-12	3/4"	47.6	55.5	65.0
23.7196.1616	-16	1"	47.6	76.0	66.0
23.7196.1620	-16	1"	54.0	78.5	79.5
23.7196.2020	-20	1.1/4"	54.0	101.7	86.0
23.7196.2024	-20	1.1/4"	63.5	102.3	98.0
23.7196.2424	-24	1.1/2"	63.5	111.0	104.0
23.7196.2432	-24	1.1/2"	79.4	113.0	119.5
23.7196.3232	-32	2"	79.4	149.3	134.0

**MATERIAL:** Carbon Steel

**FINISH:** Chromium-(VI) Free plating /  
ROHS compliant

**VERSIONS:** Stainless Steel (add an 'S'  
at the end of the REFERENCE)

# Female BSP Flat Face Swivel

23.3212.

ISO 12151-6 / ISO 8434-6 / BS 5200

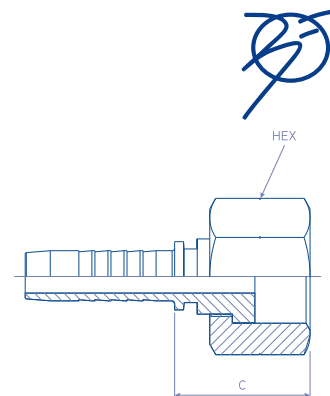

REFERENCE	hose dash	hose Ø inch	thread inch	C cut off mm	HEX mm
23.3212.0404	-4	1/4"	1/8" - 28	15.2	19
23.3212.0508	-5	5/16"	1/2" - 14	18.0	27
23.3212.0606	-6	3/8"	3/8" - 19	16.5	22
23.3212.0608	-6	3/8"	1/2" - 14	18.0	27
23.3212.0808	-8	1/2"	1/2" - 14	18.5	27
23.3212.0812	-8	1/2"	3/4" - 14	20.5	32
23.3212.1012	-10	5/8"	3/4" - 14	21.0	32
23.3212.1212	-12	3/4"	3/4" - 14	21.2	32
23.3212.1216	-12	3/4"	1" - 11	21.7	38
23.3212.1616	-16	1"	1" - 11	22.5	38

**MATERIAL:** Carbon Steel

**FINISH:** Chromium-(VI) Free plating /  
ROHS compliant

**VERSIONS:** Stainless Steel (add an 'S'  
at the end of the REFERENCE)

# Male Metric Light Serie 24° Cone Seat (CEL)

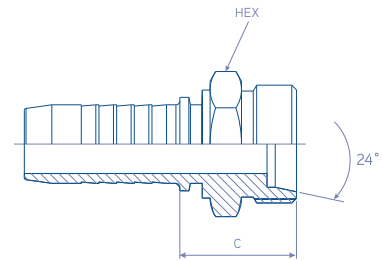

23.1000.

ISO 12151-2 / ISO 8434-1

REFERENCE	hose dash	hose Ø inch	thread inch	d - tube mm	C cut off mm	HEX mm
23.1000.0312	-3	3/16"	M12 x 1.5	6	23.0	14
23.1000.0412	-4	1/4"	M12 x 1.5	6	22.2	14
23.1000.0414	-4	1/4"	M14 x 1.5	8	22.7	17
23.1000.0416	-4	1/4"	M16 x 1.5	10	23.7	17
23.1000.0418	-4	1/4"	M18 x 1.5	12	24.7	19
23.1000.0514	-5	5/16"	M14 x 1.5	8	23.0	17
23.1000.0516	-5	5/16"	M16 x 1.5	10	24.0	17
23.1000.0518	-5	5/16"	M18 x 1.5	12	25.0	19
23.1000.0616	-6	3/8"	M16 x 1.5	10	24.0	17
23.1000.0618	-6	3/8"	M18 x 1.5	12	25.0	19
23.1000.0622	-6	3/8"	M22 x 1.5	15	28.0	24
23.1000.0818	-8	1/2"	M18 x 1.5	12	25.5	19
23.1000.0822	-8	1/2"	M22 x 1.5	15	28.5	24
23.1000.0826	-8	1/2"	M26 x 1.5	18	30.0	27
23.1000.1026	-10	5/8"	M26 x 1.5	18	30.0	27
23.1000.1030	-10	5/8"	M30 x 2.0	22	34.0	32
23.1000.1230	-12	3/4"	M30 x 2.0	22	34.2	32
23.1000.1636	-16	1"	M36 x 2.0	28	38.0	41
23.1000.2045	-20	1.1/4"	M45 x 2.0	35	43.0	46
23.1000.2452	-24	1.1/2"	M52 x 2.0	42	45.0	55

**MATERIAL:** Carbon Steel

**FINISH:** Chromium-(VI) Free plating /  
ROHS compliant

**VERSIONS:** Stainless Steel (add an 'S'  
at the end of the REFERENCE)



# Female Metric Light Serie 24° Cone Seat Swivel (DKOL)

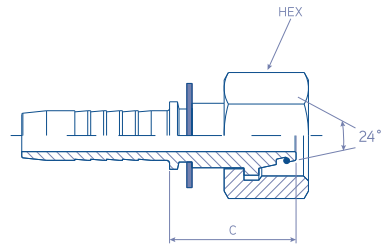

23.5013.

ISO 12151-2 / ISO 8434-1

REFERENCE	hose dash	hose Ø inch	thread inch	d tube mm	C cut off mm	HEX mm
23.5013.0312	-3	3/16"	M12 x 1.5	6	22.5	14
23.5013.0412	-4	1/4"	M12 x 1.5	6	26.7	14
23.5013.0414	-4	1/4"	M14 x 1.5	8	25.7	17
23.5013.0416	-4	1/4"	M16 x 1.5	10	21.8	19
23.5013.0418	-4	1/4"	M18 x 1.5	12	25.2	22
23.5013.0514	-5	5/16"	M14 x 1.5	8	27.5	19
23.5013.0516	-5	5/16"	M16 x 1.5	10	22.1	19
23.5013.0518	-5	5/16"	M18 x 1.5	12	25.5	22
23.5013.0616	-6	3/8"	M16 x 1.5	10	28.5	19
23.5013.0618	-6	3/8"	M18 x 1.5	12	24.6	22
23.5013.0622	-6	3/8"	M22 x 1.5	15	27.5	27
23.5013.0818	-8	1/2"	M18 x 1.5	12	30.5	22
23.5013.0822	-8	1/2"	M22 x 1.5	15	28.0	27
23.5013.0826	-8	1/2"	M26 x 1.5	18	26.8	32
23.5013.1026	-10	5/8"	M26 x 1.5	18	29.0	32
23.5013.1027	-10	5/8"	M27 x 1.5	18	29.0	32
23.5013.1030	-10	5/8"	M30 x 2.0	22	32.0	36
23.5013.1230	-12	3/4"	M30 x 2.0	22	34.7	36
23.5013.1636	-16	1"	M36 x 2.0	28	33.5	41
23.5013.2045	-20	1.1/4"	M45 x 2.0	35	38.5	50
23.5013.2452	-24	1.1/2"	M52 x 2.0	42	39.5	60

**MATERIAL:** Carbon Steel

**FINISH:** Chromium-(VI) Free plating /  
ROHS compliant

**VERSIONS:** Stainless Steel (add an 'S'  
at the end of the REFERENCE)

# 45° Swept Female Metric Light Serie 24° Cone Seat Swivel (DKOL 45)

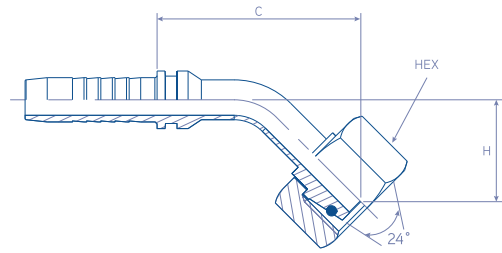

23.5043.

ISO 12151-2 / ISO 8434-1

REFERENCE	hose dash	hose Ø inch	thread inch	d tube mm	C cut off mm	H mm	HEX mm
23.5043.0312	-3	3/16"	M12 x 1.5	6	38.0	15.0	14
23.5043.0412	-4	1/4"	M12 x 1.5	6	39.0	15.0	14
23.5043.0414	-4	1/4"	M14 x 1.5	8	35.2	16.0	17
23.5043.0416	-4	1/4"	M16 x 1.5	10	36.3	17.0	19
23.5043.0418	-4	1/4"	M18 x 1.5	12	40.0	18.5	22
23.5043.0516	-5	5/16"	M16 x 1.5	10	39.0	17.0	19
23.5043.0518	-5	5/16"	M18 x 1.5	12	42.6	19.0	22
23.5043.0616	-6	3/8"	M16 x 1.5	10	54.8	20.0	19
23.5043.0618	-6	3/8"	M18 x 1.5	12	42.6	19.0	22
23.5043.0622	-6	3/8"	M22 x 1.5	15	45.0	19.0	27
23.5043.0822	-8	1/2"	M22 x 1.5	15	48.2	20.0	27
23.5043.0826	-8	1/2"	M26 x 1.5	18	49.9	21.0	32
23.5043.1026	-10	5/8"	M26 x 1.5	18	62.5	25.0	32
23.5043.1027	-10	5/8"	M27 x 1.5	18	62.5	25.0	32
23.5043.1030	-10	5/8"	M30 x 2.0	22	66.6	25.0	36
23.5043.1230	-12	3/4"	M30 x 2.0	22	78.0	30.0	36
23.5043.1636	-16	1"	M36 x 2.0	28	90.5	33.0	41
23.5043.2045	-20	1.1/4"	M45 x 2.0	35	102.5	40.0	50
23.5043.2452	-24	1.1/2"	M52 x 2.0	42	127.1	45.0	60

**MATERIAL:** Carbon Steel

**FINISH:** Chromium-(VI) Free plating / ROHS compliant

**VERSIONS:** Stainless Steel (add an 'S' at the end of the REFERENCE)



# 90° Swept Female Metric Light Serie 24° Cone Seat Swivel (DKOL 90)

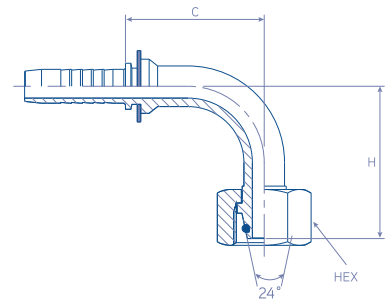

23.5093.

ISO 12151-2 / ISO 8434-1

	hose	hose Ø	thread	d tube	C cut off	H	HEX
REFERENCE	dash	inch	inch	mm	mm	mm	mm
23.5093.0312	-3	3/16"	M12 x 1.5	6	30.0	30.0	14
23.5093.0412	-4	1/4"	M12 x 1.5	6	30.7	30.0	14
23.5093.0414	-4	1/4"	M14 x 1.5	8	28.0	30.5	17
23.5093.0416	-4	1/4"	M16 x 1.5	10	28.2	33.0	19
23.5093.0418	-4	1/4"	M18 x 1.5	12	35.0	36.0	22
23.5093.0516	-5	5/16"	M16 x 1.5	10	30.5	33.0	19
23.5093.0518	-5	5/16"	M18 x 1.5	12	36.0	36.0	22
23.5093.0616	-6	3/8"	M16 x 1.5	10	34.0	36.0	19
23.5093.0618	-6	3/8"	M18 x 1.5	12	36.0	36.0	22
23.5093.0622	-6	3/8"	M22 x 1.5	15	37.5	38.0	27
23.5093.0822	-8	1/2"	M22 x 1.5	15	38.2	40.5	27
23.5093.0826	-8	1/2"	M26 x 1.5	18	48.0	47.0	32
23.5093.1026	-10	5/8"	M26 x 1.5	18	54.0	52.0	32
23.5093.1027	-10	5/8"	M27 x 1.5	18	54.0	52.0	32
23.5093.1030	-10	5/8"	M30 x 2.0	22	55.5	57.0	36
23.5093.1230	-12	3/4"	M30 x 2.0	22	55.5	57.0	36
23.5093.1236	-12	3/4"	M36 x 2.0	28	55.5	57.0	41
23.5093.1636	-16	1"	M36 x 2.0	28	78.6	70.0	41
23.5093.2045	-20	1.1/4"	M45 x 2.0	35	85.5	80.0	50
23.5093.2452	-24	1.1/2"	M52 x 2.0	42	116.3	98.0	60

**MATERIAL:** Carbon Steel

**FINISH:** Chromium-(VI) Free plating / ROHS compliant

**VERSIONS:** Stainless Steel (add an 'S' at the end of the REFERENCE)

# Male Metric Heavy Serie 24° Cone Seat (CES)

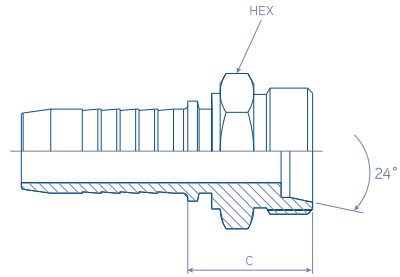

23.1100.

ISO 12151-2 / ISO 8434-1

REFERENCE	hose dash	hose Ø inch	thread inch	d - tube mm	C cut off mm	HEX mm
23.1100.0414	-4	1/4"	M14 x 1.5	6	24.7	17
23.1100.0416	-4	1/4"	M16 x 1.5	8	24.7	17
23.1100.0418	-4	1/4"	M18 x 1.5	10	25.7	19
23.1100.0516	-5	5/16"	M16 x 1.5	8	25.0	17
23.1100.0518	-5	5/16"	M18 x 1.5	10	26.0	19
23.1100.0520	-5	5/16"	M20 x 1.5	12	27.5	22
23.1100.0618	-6	3/8"	M18 x 1.5	10	26.0	19
23.1100.0620	-6	3/8"	M20 x 1.5	12	27.5	22
23.1100.0622	-6	3/8"	M22 x 1.5	14	30.0	24
23.1100.0820	-8	1/2"	M20 x 1.5	12	27.5	22
23.1100.0824	-8	1/2"	M24 x 1.5	16	32.0	27
23.1100.1024	-10	5/8"	M24 x 1.5	16	32.5	27
23.1100.1030	-10	5/8"	M30 x 2.0	20	36.0	32
23.1100.1230	-12	3/4"	M30 x 2.0	20	36.2	32
23.1100.1236	-12	3/4"	M36 x 2.0	25	41.2	41
23.1100.1636	-16	1"	M36 x 2.0	25	42.0	41
23.1100.1642	-16	1"	M42 x 2.0	30	45.5	46
23.1100.2052	-20	1.1/4"	M52 x 2.0	38	51.0	55
23.1100.2452	-24	1.1/2"	M52 x 2.0	38	51.0	55

**MATERIAL:** Carbon Steel

**FINISH:** Chromium-(VI) Free plating /  
ROHS compliant

**VERSIONS:** Stainless Steel (add an 'S'  
at the end of the REFERENCE)



# Female Metric Heavy Serie 24° Cone Seat Swivel (DKOS)

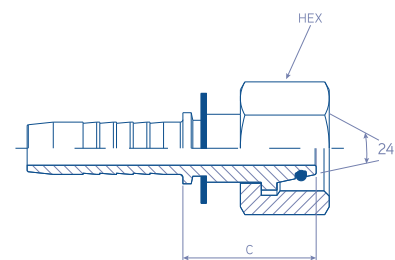

23.5113.

ISO 12151-2 / ISO 8434-1

REFERENCE	hose dash	hose Ø inch	thread inch	d - tube mm	C cut off mm	HEX mm
23.5113.0414	-4	1/4"	M14 x 1.5	6	26.2	17
23.5113.0416	-4	1/4"	M16 x 1.5	8	21.7	19
23.5113.0418	-4	1/4"	M18 x 1.5	10	26.2	22
23.5113.0518	-5	5/16"	M18 x 1.5	10	26.5	22
23.5113.0520	-5	5/16"	M20 x 1.5	12	27.5	24
23.5113.0618	-5	5/16"	M18 x 1.5	10	26.5	22
23.5113.0620	-5	5/16"	M20 x 1.5	12	27.5	24
23.5113.0622	-6	3/8"	M22 x 1.5	14	28.5	27
23.5113.0820	-8	1/2"	M20 x 1.5	12	29.0	24
23.5113.0822	-8	1/2"	M22 x 1.5	14	29.0	27
23.5113.0824	-8	1/2"	M24 x 1.5	16	28.5	30
23.5113.1030	-10	5/8"	M30 x 2.0	20	34.0	36
23.5113.1230	-12	3/4"	M30 x 2.0	20	35.7	36
23.5113.1236	-12	3/4"	M36 x 2.0	25	35.7	46
23.5113.1636	-16	1"	M36 x 2.0	25	36.5	46
23.5113.1642	-16	1"	M42 x 2.0	30	39.0	50
23.5113.2052	-20	1 1/4"	M52 x 2.0	30	46.0	50
23.5113.2452	-24	1 1/2"	M52 x 2.0	38	42.5	60

**MATERIAL:** Carbon Steel

**FINISH:** Chromium-(VI) Free plating /  
ROHS compliant

**VERSIONS:** Stainless Steel (add an 'S'  
at the end of the REFERENCE)



# 45° Swept Female Metric Heavy Serie 24° Cone Seat Swivel (DKOS 45)

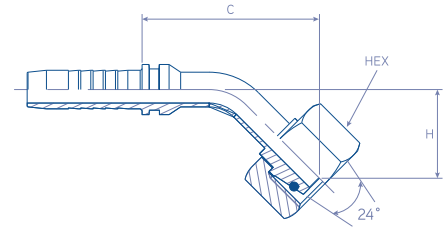

23.5143.

ISO 12151-2 / ISO 8434-1

REFERENCE	hose dash	hose Ø inch	thread inch	d tube mm	C cut off mm	H mm	HEX mm
23.5143.0414	-4	1/4"	M14 x 1.5	6	35.2	16.0	17
23.5143.0416	-4	1/4"	M16 x 1.5	8	36.3	17.0	19
23.5143.0418	-4	1/4"	M18 x 1.5	10	37.7	17.0	22
23.5143.0518	-5	5/16"	M18 x 1.5	10	40.0	17.0	22
23.5143.0520	-5	5/16"	M20 x 1.5	12	41.0	18.0	24
23.5143.0618	-6	3/8"	M18 x 1.5	10	42.6	19.0	22
23.5143.0620	-6	3/8"	M20 x 1.5	12	42.0	18.0	24
23.5143.0622	-6	3/8"	M22 x 1.5	14	43.0	19.0	27
23.5143.0820	-8	1/2"	M20 x 1.5	12	48.2	20.0	24
23.5143.0824	-8	1/2"	M24 x 1.5	16	49.9	21.0	30
23.5143.1030	-10	5/8"	M30 x 2.0	20	66.6	25.0	36
23.5143.1230	-12	3/4"	M30 x 2.0	20	70.5	30.0	36
23.5143.1236	-12	3/4"	M36 x 2.0	25	84.0	30.5	46
23.5143.1636	-16	1"	M36 x 2.0	25	87.0	36.0	46
23.5143.1642	-16	1"	M42 x 2.0	30	89.0	38.0	50
23.5143.2052	-20	1.1/4"	M52 x 2.0	38	121.3	44.0	60

**MATERIAL:** Carbon Steel

**FINISH:** Chromium-(VI) Free plating / ROHS compliant

**VERSIONS:** Stainless Steel (add an 'S' at the end of the REFERENCE)



# 90° Swept Female Metric Heavy Serie 24° Cone Seat Swivel (DKOS 90)

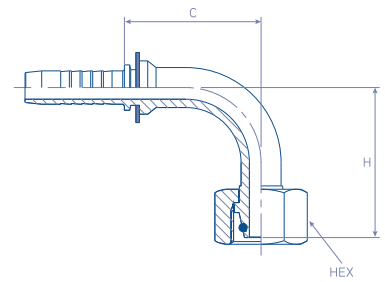

23.5193.

ISO 12151-2 / ISO 8434-1

	hose	hose Ø	thread	d tube	C cut off	H	HEX
REFERENCE	dash	inch	inch	mm	mm	mm	mm
23.5193.0414	-4	1/4"	M14 x 1.5	6	27.0	30.5	17
23.5193.0416	-4	1/4"	M16 x 1.5	8	28.2	32.5	19
23.5193.0418	-4	1/4"	M18 x 1.5	10	28.2	34.5	22
23.5193.0518	-5	5/16"	M18 x 1.5	10	30.5	36.0	22
23.5193.0520	-5	5/16"	M20 x 1.5	12	30.5	36.0	24
23.5193.0618	-6	3/8"	M18 x 1.5	10	40.0	44.0	22
23.5193.0620	-6	3/8"	M20 x 1.5	12	30.5	36.0	24
23.5193.0622	-6	3/8"	M22 x 1.5	14	33.0	37.0	27
23.5193.0820	-8	1/2"	M20 x 1.5	12	35.0	38.0	24
23.5193.0824	-8	1/2"	M24 x 1.5	16	41.0	42.5	30
23.5193.1024	-10	5/8"	M24 x 1.5	16	55.5	57.5	30
23.5193.1030	-10	5/8"	M30 x 2.0	20	55.5	57.5	36
23.5193.1230	-12	3/4"	M30 x 2.0	20	55.5	57.0	36
23.5193.1236	-12	3/4"	M36 x 2.0	25	55.5	60.0	46
23.5193.1636	-16	1"	M36 x 2.0	25	74.0	71.5	46
23.5193.1642	-16	1"	M42 x 2.0	30	74.0	75.0	50
23.5193.2052	-20	1.1/4"	M52 x 2.0	38	89.0	87.0	60

**MATERIAL:** Carbon Steel

**FINISH:** Chromium-(VI) Free plating / ROHS compliant

**VERSIONS:** Stainless Steel (add an 'S' at the end of the REFERENCE)

# Female Metric 24°/60°C one Seat Swivel (DKL)

23.5213.  
DIN 3868

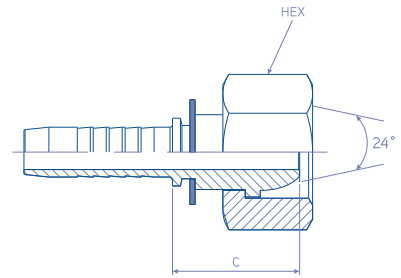

	hose	hose Ø	thread	d - tube	C cut off	HEX
REFERENCE	dash	inch	inch	mm	mm	mm
23.5213.0414	- 4	1/4"	M14 x 1.5	8	25.7	17
23.5213.0516	- 5	5/16"	M16 x 1.5	10	22.1	19
23.5213.0518	- 5	5/16"	M18 x 1.5	12	25.5	22
23.5213.0616	- 6	3/8"	M16 x 1.5	10	28.5	19
23.5213.0618	- 6	3/8"	M18 x 1.5	12	24.6	22
23.5213.0822	- 8	1/2"	M22 x 1.5	15	28.0	27
23.5213.1026	- 10	5/8"	M26 x 1.5	18	29.0	32

**MATERIAL:** Carbon Steel

**FINISH:** Chromium-(VI) Free plating /  
ROHS compliant

**VERSIONS:** Stainless Steel (add an 'S'  
at the end of the REFERENCE)

# 90° Swept Female Metric 24°/60°C Cone Seat Swivel (DKL)

23.5293.  
DIN 3868

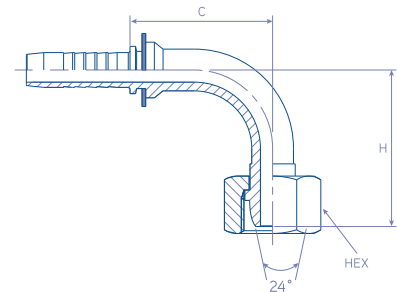

	hose	hose Ø	thread	d tube	C cut off	H	HEX
REFERENCE	dash	inch	inch	mm	mm	mm	mm
23.5293.0414	- 4	1/4"	M14 x 1.5	8	28.0	30.5	17
23.5293.0516	- 5	5/16"	M16 x 1.5	10	30.5	33.0	19
23.5293.0518	- 5	5/16"	M18 x 1.5	12	36.0	36.0	22
23.5293.0616	- 6	3/8"	M16 x 1.5	10	34.0	36.0	19
23.5293.0618	- 6	3/8"	M18 x 1.5	12	36.0	36.0	22
23.5293.0822	- 8	1/2"	M22 x 1.5	15	38.2	40.5	27
23.5293.1026	- 10	5/8"	M26 x 1.5	18	54.0	52.0	32

**MATERIAL:** Carbon Steel

**FINISH:** Chromium-(VI) Free plating /  
ROHS compliant

**VERSIONS:** Stainless Steel (add an 'S'  
at the end of the REFERENCE)



# Male Metric French Serie 24° Cone Seat (AGF)

23.1200.

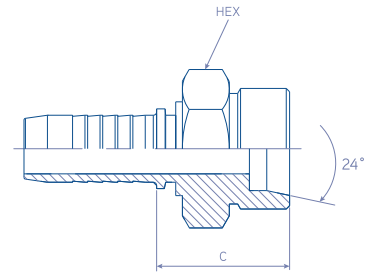

	hose	hose Ø	thread	d - tube	C cut off	HEX
REFERENCE	dash	inch	inch	mm	mm	mm
23.1200.0520	- 5	5/16"	M20 x 1.5	13.25	27.5	22
23.1200.0620	- 6	3/8"	M20 x 1.5	13.25	27.5	22
23.1200.0824	- 8	1/2"	M24 x 1.5	16.75	32.0	24
23.1200.1030	- 10	5/8"	M30 x 1.5	21.25	32.5	30
23.1200.1230	- 12	3/4"	M30 x 1.5	21.25	36.0	30
23.1200.1236	- 12	3/4"	M36 x 1.5	26.75	36.2	36
23.1200.1645	- 16	1"	M45 x 1.5	33.50	41.2	46

**MATERIAL:** Carbon Steel

**FINISH:** Chromium-(VI) Free plating /  
ROHS compliant

**VERSIONS:** Stainless Steel (add an 'S'  
at the end of the REFERENCE)

# Female Metric French Serie 24° Cone Seat Swivel (DKF)

23.5513.

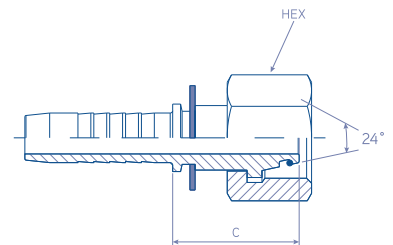

	hose	hose Ø	thread	d - tube	C cut off	HEX
REFERENCE	dash	inch	inch	mm	mm	mm
23.5513.0520	- 5	5/16"	M20 x 1.5	13.25	27.5	27
23.5513.0620	- 6	3/8"	M20 x 1.5	13.25	27.5	27
23.5513.0824	- 8	1/2"	M24 x 1.5	16.75	32.0	30
23.5513.1030	- 10	5/8"	M30 x 1.5	21.25	32.5	36
23.5513.1230	- 12	3/4"	M30 x 1.5	21.25	36.0	36
23.5513.1236	- 12	3/4"	M36 x 1.5	26.75	36.2	46
23.5513.1645	- 16	1"	M45 x 1.5	33.50	41.2	55

**MATERIAL:** Carbon Steel

**FINISH:** Chromium-(VI) Free plating /  
ROHS compliant

**VERSIONS:** Stainless Steel (add an 'S'  
at the end of the REFERENCE)

# 90° Swept Female Metric French Serie 24° Cone Seat Swivel (DKF)

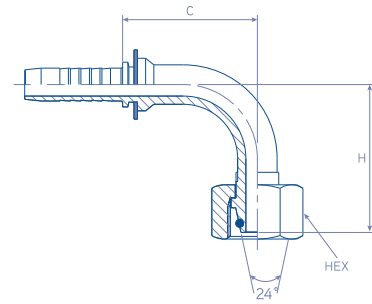

23.5593.

REFERENCE	hose dash	hose Ø inch	thread inch	d tube mm	C cut off mm	H mm	HEX mm
23.5593.0520	- 5	5/16"	M20 x 1.5	13.25	30.5	36.0	27
23.5593.0620	- 6	3/8"	M20 x 1.5	13.25	30.5	36.0	27
23.5593.0824	- 8	1/2"	M24 x 1.5	16.75	41.0	42.5	30
23.5593.1030	- 10	5/8"	M30 x 1.5	21.25	55.5	57.5	36
23.5593.1236	- 12	3/4"	M36 x 1.5	26.75	55.5	60.0	46
23.5593.1645	- 16	1"	M45 x 1.5	33.50	74.0	75.0	55

**MATERIAL:** Carbon Steel

**FINISH:** Chromium-(VI) Free plating / ROHS compliant

**VERSIONS:** Stainless Steel (add an 'S' at the end of the REFERENCE)

# Female JIS 60° Cone Seat Swivel (TOYOTA)

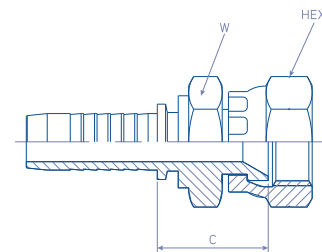

23.3712.

JIS B8363

REFERENCE	hose dash	hose Ø inch	thread inch	d - tube mm	C cut off mm	W mm	HEX mm
23.3712.0404	-4	1/4"	1/4" - 19	21	19	19	19
23.3712.0606	-6	3/8"	3/8" - 19	22	22	19	19
23.3712.0808	-8	1/2"	1/2" - 14	25	27	22	22
23.3712.1212	-12	3/4"	3/4" - 14	28	32	30	30
23.3712.1616	-16	1"	1" - 11	33	38	32	32
23.3712.2020	-20	1.1/4"	1.1/4" - 11	35	50	46	46
23.3712.2424	-24	1.1/2"	1.1/2" - 11	28	55	50	50

**MATERIAL:** Carbon Steel

**FINISH:** Chromium-(VI) Free plating / ROHS compliant

**VERSIONS:** Stainless Steel (add an 'S' at the end of the REFERENCE)



# Female JIS 60° Cone Seat Swivel (KOMATSU)

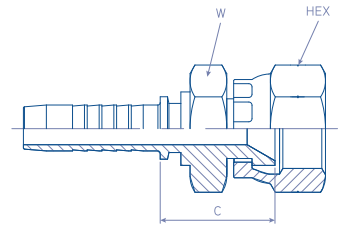

23.5911.  
JIS B8363

	hose	hose Ø	thread	d tube	C cut off	W	HEX
REFERENCE	dash	inch	inch	mm	mm	mm	mm
23.5911.0414	-4	1/4"	M14 x 1.5	22.2	19	27	19
23.5911.0616	-5	5/16"	M16 x 1.5	23.5	22	27	19
23.5911.0618	-6	3/8"	M18 x 1.5	24.5	24	30	19
23.5911.0822	-8	1/2"	M22 x 1.5	27.0	27	36	22
23.5911.1024	-10	5/8"	M24 x 1.5	28.5	32	46	24
23.5911.1230	-12	3/4"	M30 x 1.5	31.7	36	55	30
23.5911.1633	-16	1"	M33 x 1.5	33.5	41	36	32
23.5911.2036	-20	1.1/4"	M36 x 1.5	37.5	46	46	41
23.5911.2442	-24	1.1/2"	M42 x 1.5	42.0	55	55	50

**MATERIAL:** Carbon Steel

**FINISH:** Chromium-(VI) Free plating /  
ROHS compliant

**VERSIONS:** Stainless Steel (add an 'S'  
at the end of the REFERENCE)

# Metric Standpipe (BEL)

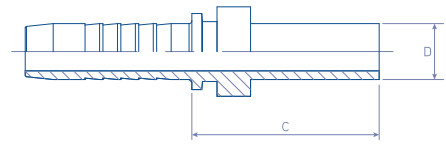

23.6000.

REFERENCE	hose dash	hose Ø inch	d - tube inch	C cut off mm
23.6000.0304	-3	3/16"	4	24.5
23.6000.0306	-3	3/16"	6	29.5
23.6000.0308	-3	3/16"	8	31.0
23.6000.0406	-4	1/4"	6	28.0
23.6000.0408	-4	1/4"	8	30.5
23.6000.0410	-4	1/4"	10	33.0
23.6000.0412	-4	1/4"	12	33.0
23.6000.0510	-5	5/16"	10	33.5
23.6000.0512	-5	5/16"	12	33.5
23.6000.0610	-6	3/8"	10	30.5
23.6000.0612	-6	3/8"	12	30.5
23.6000.0614	-6	3/8"	14	30.5
23.6000.0615	-6	3/8"	15	30.5
23.6000.0814	-8	1/2"	14	36.0
23.6000.0815	-8	1/2"	15	32.0
23.6000.0816	-8	1/2"	16	37.0
23.6000.0818	-8	1/2"	18	37.0
23.6000.1018	-10	5/8"	18	34.0
23.6000.1020	-10	5/8"	20	44.0
23.6000.1022	-10	5/8"	22	44.5
23.6000.1220	-12	3/4"	20	44.5
23.6000.1222	-12	3/4"	22	36.5
23.6000.1225	-12	3/4"	25	49.5
23.6000.1625	-16	1"	25	51.0
23.6000.1628	-16	1"	28	40.0
23.6000.1630	-16	1"	30	54.0
23.6000.1638	-16	1"	38	60.0
23.6000.2030	-20	1.1/4"	30	58.0
23.6000.2035	-20	1.1/4"	35	48.0
23.6000.2038	-20	1.1/4"	38	62.0
23.6000.2438	-24	1.1/2"	38	63.0
23.6000.2442	-24	1.1/2"	42	50.0

**MATERIAL:** Carbon Steel

**FINISH:** Chromium-(VI) Free plating /  
ROHS compliant

**VERSIONS:** Stainless Steel (add an 'S'  
at the end of the REFERENCE)



# 45° Swept Metric Standpipe (BEL 45)

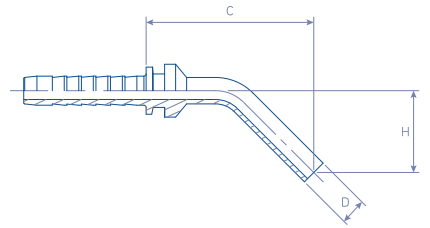

23.6040.

REFERENCE	hose dash	hose Ø inch	d tube inch	C cut off mm	H mm
23.6040.0306	-3	3/16"	6	33	26
23.6040.0308	-3	3/16"	8	38	26
23.6040.0406	-4	1/4"	6	41	24
23.6040.0408	-4	1/4"	8	43	25
23.6040.0410	-4	1/4"	10	47	30
23.6040.0412	-4	1/4"	12	47	30
23.6040.0510	-5	5/16"	10	49	30
23.6040.0512	-5	5/16"	12	53	32
23.6040.0610	-6	3/8"	10	50	33
23.6040.0612	-6	3/8"	12	52	33
23.6040.0614	-6	3/8"	14	43	34
23.6040.0615	-6	3/8"	15	45	37
23.6040.0814	-8	1/2"	14	42	34
23.6040.0815	-8	1/2"	15	46	37
23.6040.0816	-8	1/2"	16	45	36
23.6040.0818	-8	1/2"	18	61	32
23.6040.1018	-10	5/8"	18	61	32
23.6040.1020	-10	5/8"	20	62	34
23.6040.1022	-10	5/8"	22	68	35
23.6040.1220	-12	3/4"	20	68	35
23.6040.1222	-12	3/4"	22	68	35
23.6040.1225	-12	3/4"	25	75	39
23.6040.1625	-16	1"	25	74	39
23.6040.1628	-16	1"	28	87	49
23.6040.1630	-16	1"	30	84	43
23.6040.2030	-20	1.1/4"	30	85	43
23.6040.2035	-20	1.1/4"	35	93	45
23.6040.2038	-20	1.1/4"	38	94	50
23.6040.2438	-24	1.1/2"	38	94	50
23.6040.2442	-24	1.1/2"	42	113	57

**MATERIAL:** Carbon Steel

**FINISH:** Chromium-(VI) Free plating / ROHS compliant

**VERSIONS:** Stainless Steel (add an 'S' at the end of the REFERENCE)



# 90° Swept Metric Standpipe (BEL 90)

23.6090.

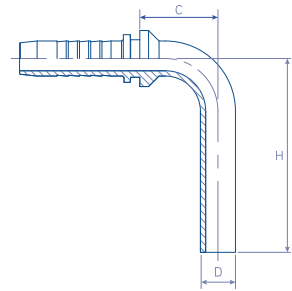

REFERENCE	hose dash	hose Ø inch	d tube inch	C cut off mm	H mm
23.6090.0306	-3	3/16"	6	24	37
23.6090.0308	-3	3/16"	8	24	39
23.6090.0406	-4	1/4"	6	23	32
23.6090.0408	-4	1/4"	8	25	34
23.6090.0410	-4	1/4"	10	25	43
23.6090.0412	-4	1/4"	12	25	37
23.6090.0510	-5	5/16"	10	29	40
23.6090.0512	-5	5/16"	12	29	45
23.6090.0610	-6	3/8"	10	27	40
23.6090.0612	-6	3/8"	12	30	44
23.6090.0614	-6	3/8"	14	33	45
23.6090.0615	-6	3/8"	15	38	53
23.6090.0814	-8	1/2"	14	33	49
23.6090.0815	-8	1/2"	15	39	53
23.6090.0816	-8	1/2"	16	42	56
23.6090.0818	-8	1/2"	18	42	57
23.6090.1018	-10	5/8"	18	42	57
23.6090.1020	-10	5/8"	20	42	66
23.6090.1022	-10	5/8"	22	53	71
23.6090.1220	-12	3/4"	20	49	66
23.6090.1222	-12	3/4"	22	54	71
23.6090.1225	-12	3/4"	25	57	76
23.6090.1625	-16	1"	25	58	76
23.6090.1628	-16	1"	28	65	83
23.6090.1630	-16	1"	30	66	89
23.6090.2030	-20	1.1/4"	30	67	89
23.6090.2035	-20	1.1/4"	35	77	97
23.6090.2038	-20	1.1/4"	38	81	106
23.6090.2438	-24	1.1/2"	38	81	106
23.6090.2442	-24	1.1/2"	42	92	118

**MATERIAL:** Carbon Steel

**FINISH:** Chromium-(VI) Free plating / ROHS compliant

**VERSIONS:** Stainless Steel (add an 'S' at the end of the REFERENCE)



# Metric Banjo (RNM)

23.6400.

DIN 7642

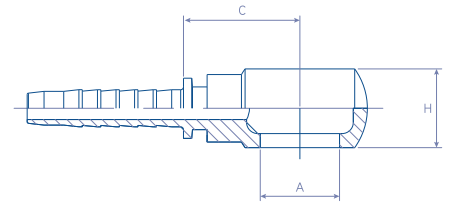

REFERENCE	hose dash	hose Ø inch	C cut off inch	A mm	H mm
23.6400.0310	-3	3/16"	15.5	10.2	10.0
23.6400.0312	-3	3/16"	17.0	12.2	12.0
23.6400.0410	-4	1/4"	17.0	10.2	10.0
23.6400.0412	-4	1/4"	21.0	12.2	12.0
23.6400.0414	-4	1/4"	21.0	14.2	14.0
23.6400.0416	-4	1/4"	22.5	16.2	18.0
23.6400.0514	-5	5/16"	19.0	14.2	14.0
23.6400.0516	-5	5/16"	22.5	16.2	18.0
23.6400.0518	-5	5/16"	24.0	18.2	20.0
23.6400.0614	-6	3/8"	21.0	14.2	14.0
23.6400.0616	-6	3/8"	22.5	16.2	18.0
23.6400.0618	-6	3/8"	24.0	18.2	20.0
23.6400.0622	-6	3/8"	28.1	22.2	22.0
23.6400.0816	-8	1/2"	26.0	16.2	18.0
23.6400.0818	-8	1/2"	24.5	18.2	20.0
23.6400.0822	-8	1/2"	27.5	22.2	22.0
23.6400.1022	-10	5/8"	27.5	22.2	22.0
23.6400.1026	-10	5/8"	32.0	26.2	29.0
23.6400.1226	-12	3/4"	32.0	26.2	29.0
23.6400.1230	-12	3/4"	36.5	30.2	37.0
23.6400.1630	-16	1"	36.5	30.2	37.0

**MATERIAL:** Carbon Steel

**FINISH:** Chromium-(VI) Free plating /  
ROHS compliant

**VERSIONS:** Stainless Steel (add an 'S'  
at the end of the REFERENCE)

# BSP Banjo (RNR)

23.6500.  
BS 5200

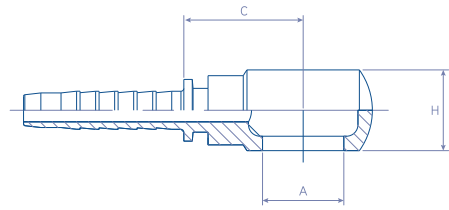

REFERENCE	hose dash	hose Ø inch	inch	C cut off mm	A mm	H mm
23.6500.0302	-3	3/16"	1/8"	19.0	1/8"	16.0
23.6500.0304	-3	3/16"	1/4"	20.0	1/4"	15.0
23.6500.0404	-4	1/4"	1/4"	19.2	1/4"	15.0
23.6500.0406	-4	1/4"	3/8"	21.7	3/8"	18.0
23.6500.0504	-5	5/16"	1/4"	19.0	1/4"	15.0
23.6500.0506	-5	5/16"	3/8"	22.5	3/8"	20.0
23.6500.0604	-6	3/8"	1/4"	19.5	1/4"	15.0
23.6500.0606	-6	3/8"	3/8"	22.0	3/8"	20.0
23.6500.0608	-6	3/8"	1/2"	27.5	1/2"	25.0
23.6500.0806	-8	1/2"	3/8"	22.5	3/8"	20.0
23.6500.0808	-8	1/2"	1/2"	28.0	1/2"	25.0
23.6500.1018	-10	5/8"	1/2"	28.0	1/2"	25.0
23.6500.1010	-10	5/8"	5/8"	27.5	5/8"	27.0
23.6500.1012	-10	5/8"	3/4"	31.5	3/4"	31.0
23.6500.1212	-12	3/4"	3/4"	32.0	3/4"	31.0
23.6500.1216	-12	3/4"	1"	39.7	1"	42.0
23.6500.1616	-16	1"	1"	40.5	1"	42.0

**MATERIAL:** Carbon Steel

**FINISH:** Chromium-(VI) Free plating / ROHS compliant

**VERSIONS:** Stainless Steel (add an 'S' at the end of the REFERENCE)



# BSP Banjo Bolt

88.1600.

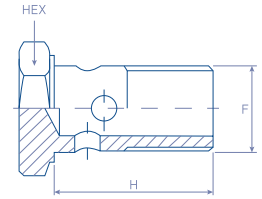

REFERENCE	F inch	H mm	HEX mm
88.1600.02	1/8"	19.0	14
88.1600.04	1/4"	25.0	19
88.1600.06	3/8"	31.0	22
88.1600.08	1/2"	38.0	27
88.1600.10	5/8"	41.0	30
88.1600.12	3/4"	46.0	32
88.1600.16	1"	58.0	41

**MATERIAL:** Carbon Steel

**FINISH:** Chromium-(VI) Free plating /  
ROHS compliant

# BSP Banjo Double Bolt

88.1602.

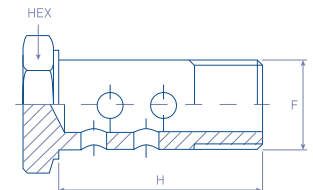

REFERENCE	F inch	H mm	HEX mm
88.1602.02	1/8"	33.0	14
88.1602.04	1/4"	43.0	19
88.1602.06	3/8"	51.0	22
88.1602.08	1/2"	63.0	27
88.1602.12	3/4"	80.0	32
88.1602.16	1"	110.0	41
88.1600.16	1"	58.0	41

**MATERIAL:** Carbon Steel

**FINISH:** Chromium-(VI) Free plating /  
ROHS compliant

# Metric Banjo Bolt

88.1650.

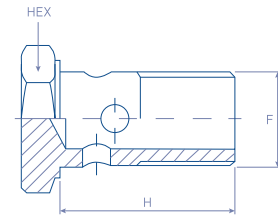

REFERENCE	F mm	H mm	HEX mm
88.1650.08	M8 x 1.0	16.0	12
88.1650.10	M10 x 1.0	19.0	14
88.1650.12	M12 x 1.5	23.0	17
88.1650.14	M14 x 1.5	25.0	19
88.1650.16	M16 x 1.5	31.0	22
88.1650.18	M18 x 1.5	36.0	24
88.1650.20	M20 x 1.5	38.0	27
88.1650.22	M22 x 1.5	38.0	27
88.1650.24	M24 x 1.5	41.0	30
88.1650.26	M26 x 1.5	46.0	32
88.1650.30	M30 x 1.5	58.0	38

**MATERIAL:** Carbon Steel

**FINISH:** Chromium-(VI) Free plating / ROHS compliant

# Metric Banjo Double Bolt

88.1652.

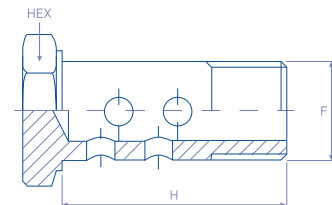

REFERENCE	F mm	H mm	Hex mm
88.1652.08	M8 x 1.0	29.0	12
88.1652.10	M10 x 1.0	33.0	14
88.1652.12	M12 x 1.5	37.0	17
88.1652.14	M14 x 1.5	43.0	19
88.1652.16	M16 x 1.5	51.0	22
88.1652.18	M18 x 1.5	57.0	24
88.1652.22	M22 x 1.5	63.0	27

**MATERIAL:** Carbon Steel

**FINISH:** Chromium-(VI) Free plating / ROHS compliant



# Hose Connector

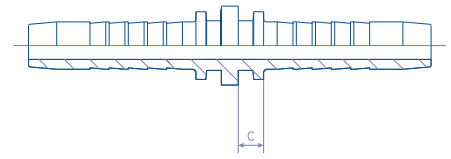

23.8100.

REFERENCE	hose dash	hose inch	C cut off mm
23.8100.03	-3	3/16"	17.0
23.8100.04	-4	1/4"	17.0
23.8100.05	-5	5/16"	17.0
23.8100.06	-6	3/8"	17.0
23.8100.08	-8	1/2"	18.0
23.8100.10	-10	5/8"	18.0
23.8100.12	-12	3/4"	19.0
23.8100.16	-16	1"	21.0

# Brazing Tail

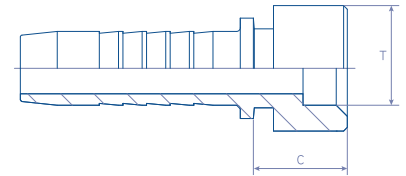

23.8150.

REFERENCE	hose dash	hose inch	C cut off mm	T inch
23.8150.03	-3	3/16"	11.0	6.0
23.8150.04	-4	1/4"	12.5	8.0
23.8150.05	-5	5/16"	13.0	10.0
23.8150.06	-6	3/8"	14.0	12.0
23.8150.08	-8	1/2"	15.5	15.0
23.8150.10	-10	5/8"	16.5	18.0
23.8150.12	-12	3/4"	18.0	20.0
23.8150.16	-16	1"	20.5	25.0

**MATERIAL:** Carbon Steel

**FINISH:** Chromium-(VI) Free plating /  
ROHS compliant

**VERSIONS:** Stainless Steel (add an 'S'  
at the end of the REFERENCE)

# Staple Lock Male

23.8300.

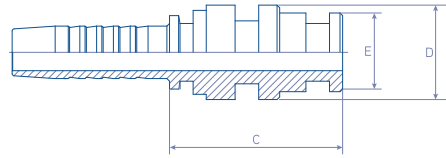

REFERENCE	hose dash	hose Ø inch	C cut off inch	D mm	E mm
23.8300.04	-4	1/4"	35.5	14.9	9.9
23.8300.06	-6	3/8"	34.5	19.9	13.9
23.8300.08	-8	1/2"	35.0	23.9	17.9
23.8300.10	-10	5/8"	36.0	25.9	20.9
23.8300.12	-12	3/4"	35.5	28.9	23.9
23.8300.16	-16	1"	44.0	38.9	30.9
23.8300.20	-20	1.1/4"	47.0	45.9	37.9
23.8300.24	-24	1.1/2"	51.0	54.9	46.9
23.8300.32	-32	2"	57.0	63.9	55.9

**MATERIAL:** Carbon Steel

**FINISH:** Chromium-(VI) Free plating / ROHS compliant

# Balwash Female Swivel (Karcher)

23.6213.

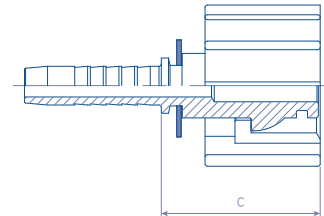

REFERENCE	hose dash	hose inch	thread	C cut off mm
23.6213.0422	-4	1/4"	M22 x 1.5	31.0
23.6213.0522	-4	5/16"	M22 x 1.5	31.0
23.6213.0622	-5	3/8"	M22 x 1.5	31.0

**MATERIAL:** Carbon Steel

**FINISH:** Chromium-(VI) Free plating / ROHS compliant



# Balwash Standpipe wit O-ring (Karcher)

23.6214.

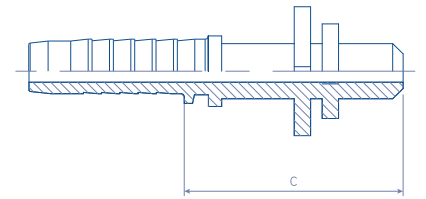

	hose	hose	tube	C cut off
REFERENCE	dash	inch		mm
23.6214.04	-4	1/4"	10.0	33.0
23.6214.05	-4	5/16"	10.0	33.0

**MATERIAL:** Carbon Steel

**FINISH:** Chromium-(VI) Free plating /  
ROHS compliant

# Balwash Rubber Handle

11.800.

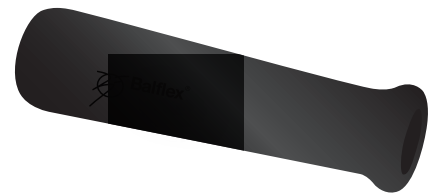

	hose	hose	I.D.
REFERENCE	dash	inch	mm
11.800.18	-5	5/16"	18.0
11.800.21	-6	3/8"	21.0

**MATERIAL:** Rubber

**VERSIONS:** Blue colour (add an 'A'  
at the end of the REFERENCE)



## BSP Bonded Seals

88.2003.

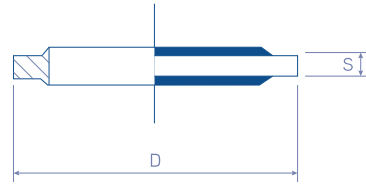

REFERENCE	I inch	S mm	D mm
88.2003.02	1/8"	2.1	16.0
88.2003.04	1/4"	2.1	20.5
88.2003.02	1/8"	2.1	16.0
88.2003.04	1/4"	2.1	20.5
88.2003.02	1/8"	2.1	16.0
88.2003.04	1/4"	2.1	20.5
88.2003.02	1/8"	2.1	16.0
88.2003.04	1/4"	2.1	20.5
88.2003.02	1/8"	2.1	16.0
88.2003.04	1/4"	2.1	20.5

**MATERIAL:** Rubber Ring (NBR) and mild steel ring

**FINISH:** Chromium-(VI) Free plating / ROHS compliant

**VERSIONS:** Stainless Steel (add an 'S' at the end of the REFERENCE)

## Metric Bonded Seals

88.2004.

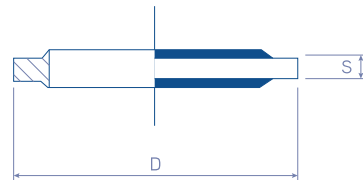

REFERENCE	I inch	S mm	D mm
88.2004.06	6	1.3	12.0
88.2004.08	8	1.3	14.0
88.2004.10	10	2.1	16.0
88.2004.12	12	2.1	18.0
88.2004.14	14	2.1	22.0
88.2004.16	16	2.1	25.0
88.2004.18	18	2.5	25.0
88.2004.20	20	2.5	28.0
88.2004.22	22	2.5	32.0
88.2004.24	24	2.5	33.0
88.2004.26	26	2.5	35.0
88.2004.30	30	2.5	39.0

**MATERIAL:** Rubber Ring (NBR) and mild steel ring

**FINISH:** Chromium-(VI) Free plating / ROHS compliant

**VERSIONS:** Stainless Steel (add an 'S' at the end of the REFERENCE)



# Split Flange 3000 PSI (code 61)

88.5300.

ISO 6162-1 / SAE J518

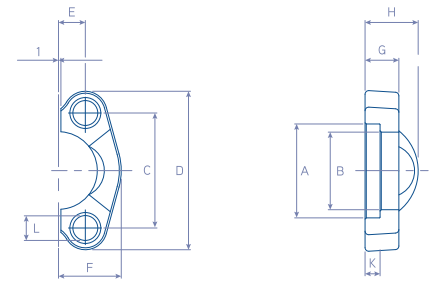

REFERENCE	size	A	B	C	D	E	F	G	H	K	L	Bolts	
	inch	mm	mm	mm	mm	mm	mm	mm	mm	mm	mm	M	UNC
88.5300.08	1/2"	31	24	38	54	9	23	13	19	6	9	M8	5/16"
88.5300.12	3/4"	39	32	48	65	11	26	14	22	6	11	M10	3/8"
88.5300.16	1"	45	38	52	70	13	29	16	24	7	11	M10	3/8"
88.5300.20	1.1/4"	52	44	59	79	15	36	14	22	7	12	M10	7/16"
88.5300.24	1.1/2"	61	51	70	94	18	41	16	25	7	15	M14	1/2"
88.5300.32	2"	72	63	78	102	21	48	16	26	9	14	M12	1/2"

**MATERIAL:** Carbon Steel

**FINISH:** Chromium-(VI) Free plating / ROHS compliant

**VERSIONS:** Uncut flange (88.5302)

# Split Flange 6000 PSI (code 62)

88.5600.

ISO 6162-1 / SAE J518

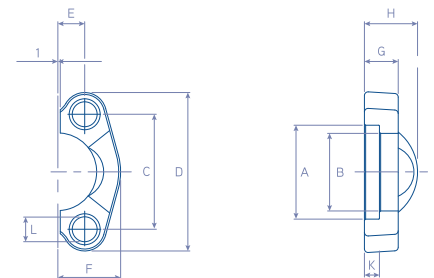

REFERENCE	size	A	B	C	D	E	F	G	H	K	L	Bolts	
	inch	mm	mm	mm	mm	mm	mm	mm	mm	mm	mm	M	UNC
88.5600.08	1/2"	33	25	41	56	9	24	16	22	7	9	M8	5/16"
88.5600.12	3/4"	42	33	51	71	12	30	19	28	8	11	M10	3/8"
88.5600.16	1"	48	39	57	81	14	35	24	33	9	13	M12	7/16"
88.5600.20	1.1/4"	55	44	67	95	16	39	27	38	10	15	M14	1/2"
88.5600.24	1.1/2"	64	52	79	113	18	48	30	43	12	17	M16	5/8"
88.5600.32	2"	80	68	97	133	22	57	37	52	12	21	M20	3/4"

**MATERIAL:** Carbon Steel

**FINISH:** Chromium-(VI) Free plating / ROHS compliant

**VERSIONS:** Uncut flange (88.5602)

# Interlock Hydraulic Fittings

---

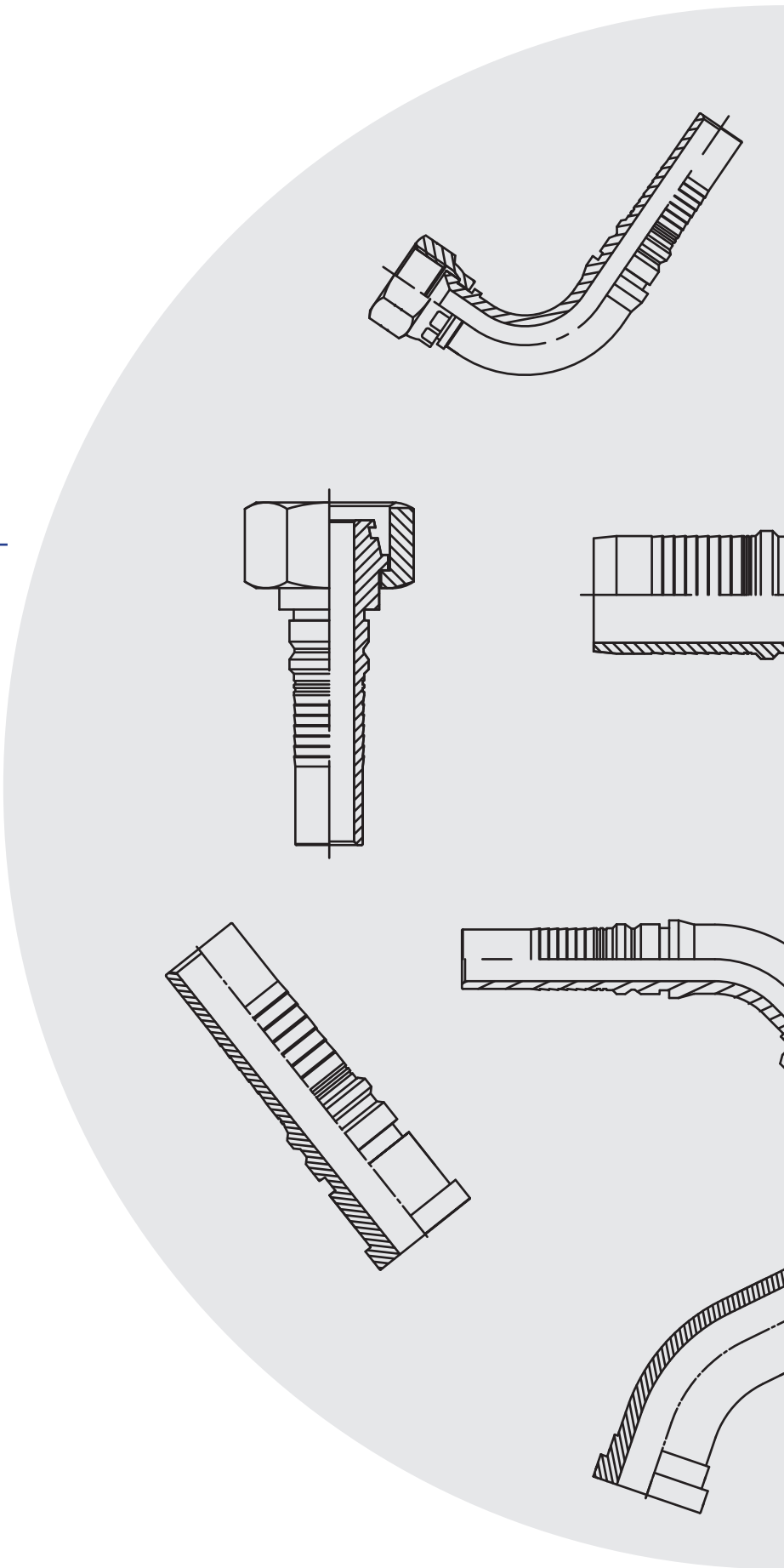

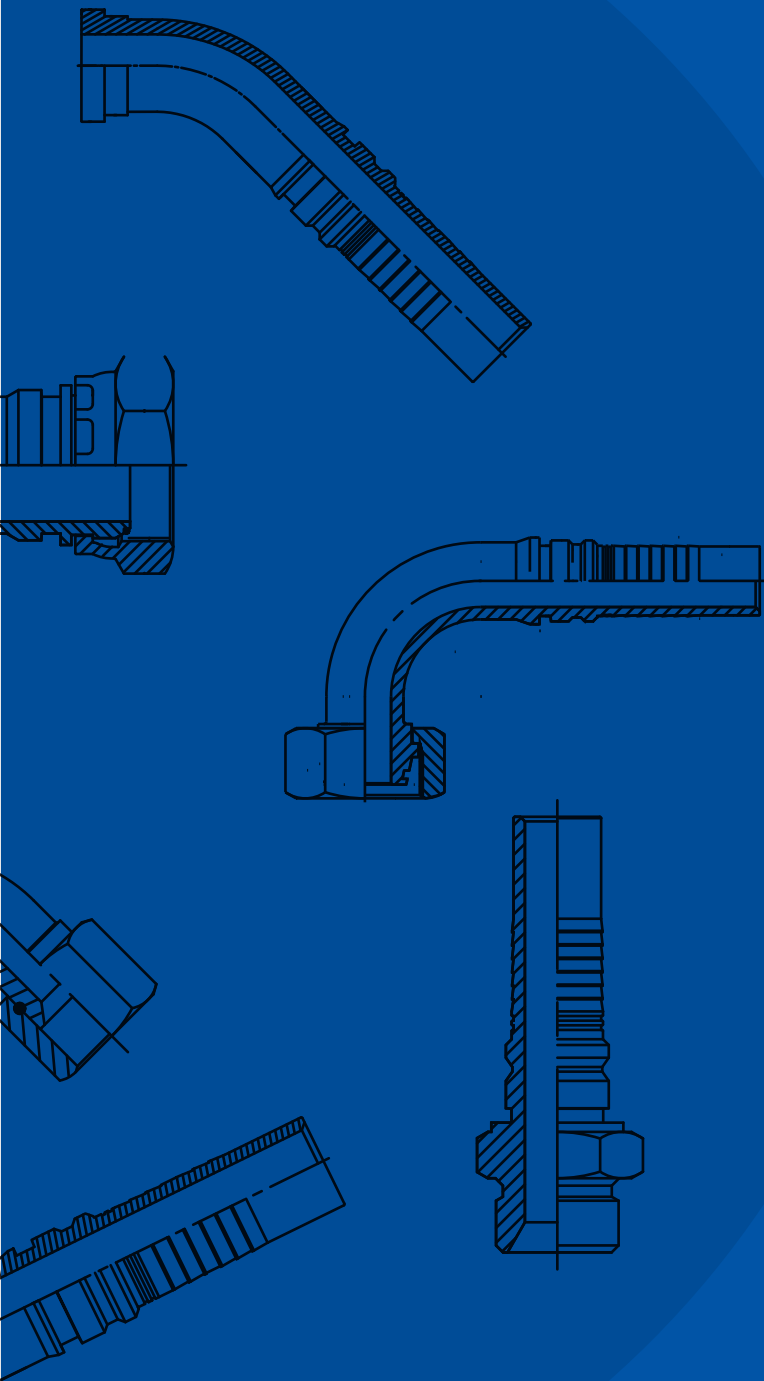

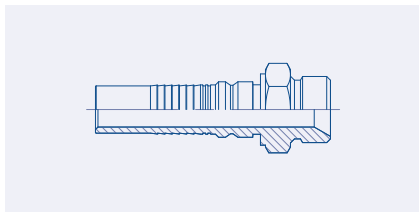

**Interlock Male BSP Parallel Pipe (AGR)**

26.0100

pag. 94

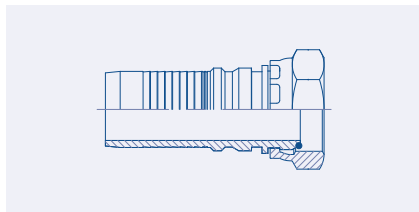

**Interlock Female BSP Parallel Pipe with O-ring Swivel (DKOR)**

26.3112

pag. 94

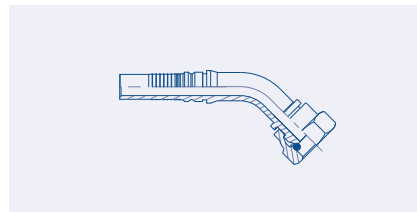

**Interlock 45° Swept Female BSP Parallel Pipe with O-ring Swivel (DKOR 45°)**

26.3142

pag. 95

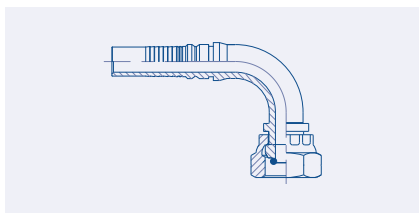

**Interlock 90° Swept Female BSP Parallel Pipe with O-ring Swivel (DKOR 90°)**

26.3192

pag. 95

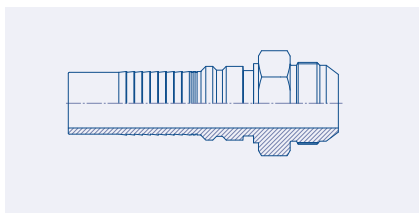

**Interlock Male JIC 37° (AGJ)**

26.2000

pag. 96

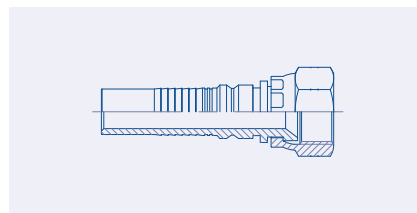

**Interlock Female JIC 37° Swivel (DKJ)**

26.4012

pag. 96

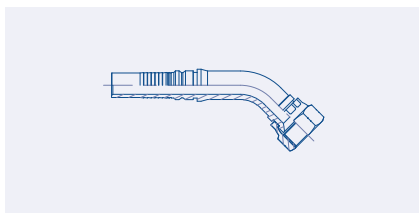

**Interlock 45° Swept Female JIC 37° Swivel (DKJ 45°)**

26.4042

pag. 97

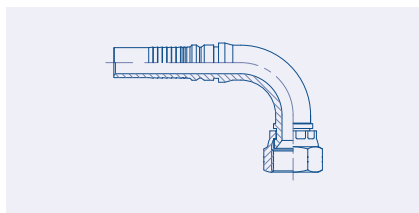

**Interlock 90° Swept Female JIC 37° Swivel (DKJ 90°)**

26.4092

pag. 97

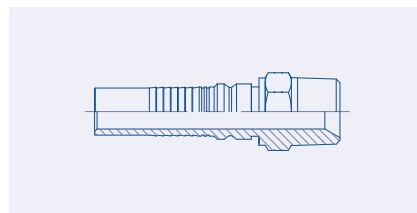

**Interlock Male NPTF Pipe (AGN)**

26.0400

pag. 98

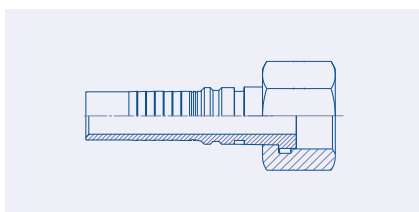

**Interlock Female ORFS Swivel**

26.4414

pag. 98

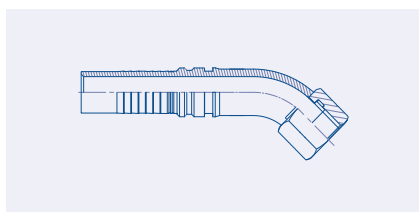

**Interlock 45° Swept Female ORFS Swivel**

26.4444

pag. 99

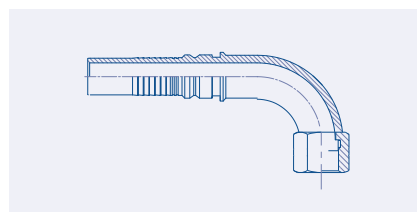

**Interlock 90° Swept Female ORFS Swivel**

26.4494

pag. 99

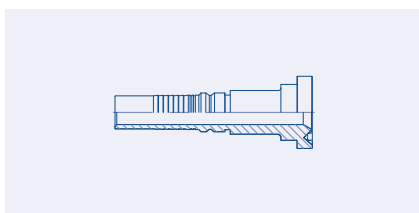

**Interlock Straight SAE 3000 PSI (code 61) Flange (SFL)**

26.7013

pag. 100

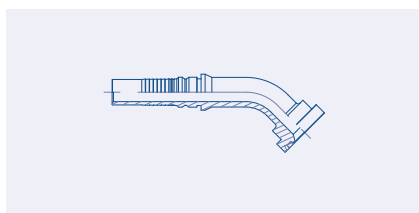

**Interlock 45° Swept SAE 3000 PSI (code 61) Flange (SFL 45°)**

26.7043

pag. 100

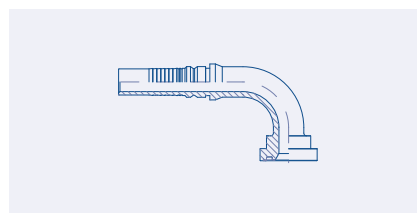

**Interlock 90° Swept SAE 3000 PSI (code 61) Flange (SFL 90°)**

26.7093

pag. 101

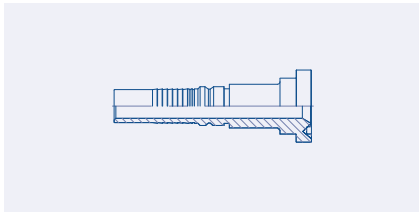

**Interlock Straight SAE 6000 PSI (code 62) Flange (SFS)**  
26.7016 pag. 101

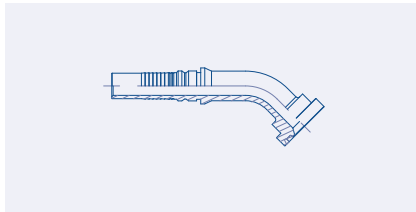

**Interlock 45° Swept SAE 6000 PSI (code 62) Flange (SFS 45°)**  
26.7046 pag. 102

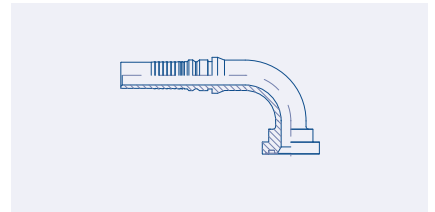

**Interlock 90° Swept SAE 6000 PSI (code 62) Flange (SFS 90°)**  
26.7096 pag. 102

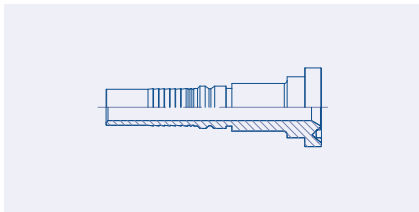

**Interlock Straight SUPERCAT Flange**  
26.7116 pag. 103

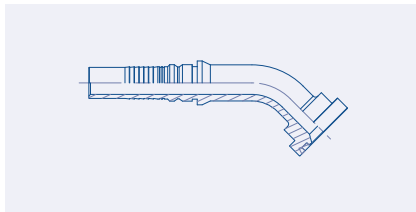

**Interlock 45° Swept SUPERCAT Flange**  
26.7146 pag. 103

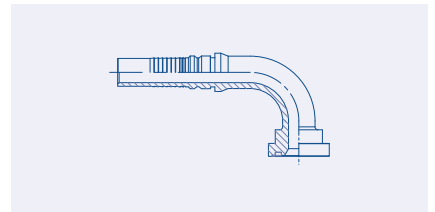

**Interlock 90° Swept SUPERCAT Flange**  
26.7196 pag. 104

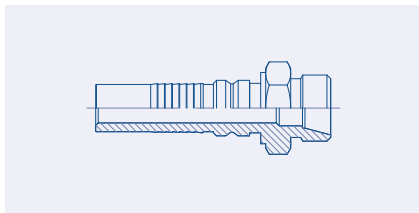

**Interlock Male Metric Heavy Serie 24° Cone Seat (CES)**  
26.1100 pag. 104

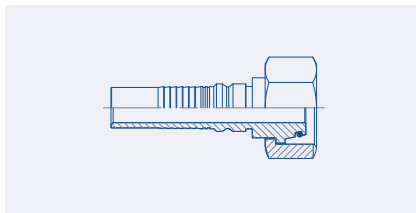

**Interlock Female Metric Heavy Serie 24° Cone Seat Swivel (DKOS) 26.5113**  
pag. 105

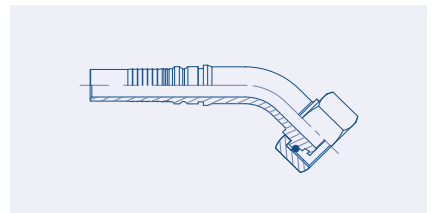

**Interlock 45° Swept Female Metric Heavy Serie 24° Cone Seat Swivel (DKOS 45) 26.5143**  
pag. 105

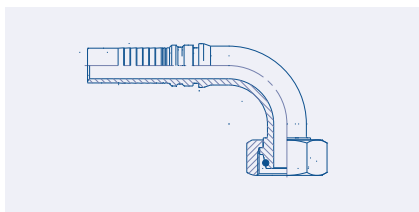

**Interlock 90° Swept Female Metric Heavy Serie 24° Cone Seat Swivel (DKOS 90) 26.5193**  
pag. 106

# Interlock Male BSP Parallel Pipe (AGR)

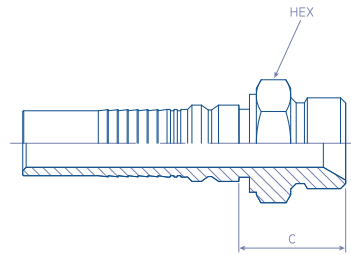

26.0100.

ISO 12151-6 / ISO 8434-6 / BS 5200

REFERENCE	hose dash	hose Ø inch	thread inch	C Cut Off mm	HEX mm
26.0100.1212	-12	3/4"	3/4" - 14	36.5	32
26.0100.1616	-16	1"	1" - 11	42.5	41
26.0100.2020	-20	1.1/4"	1.1/4" - 11	46.7	50
26.0100.2424	-24	1.1/2"	1.1/2" - 11	49.5	55
26.0100.3232	-32	2"	2" - 11	56.5	70

**MATERIAL:** Carbon Steel

**FINISH:** Chromium-(VI) Free plating / ROHS compliant

**VERSIONS:** Stainless Steel (add an 'S' at the end of the REFERENCE)

# Interlock Female BSP Parallel Pipe with O-ring Swivel (DKOR)

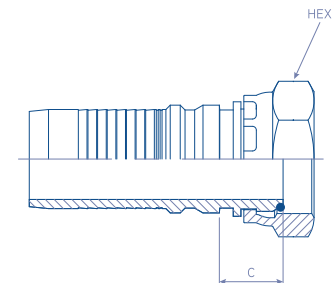

26.3112.

ISO 12151-6 / ISO 8434-6 / BS 5200

REFERENCE	hose dash	hose Ø inch	thread inch	C Cut Off mm	HEX mm
26.3112.1212	-12	3/4"	3/4" - 14	22.0	32
26.3112.1616	-16	1"	1" - 11	25.2	38
26.3112.2020	-20	1.1/4"	1.1/4" - 11	29.2	50
26.3112.2424	-24	1.1/2"	1.1/2" - 11	30.5	55
26.3112.3232	-32	2"	2" - 11	31.0	70

**MATERIAL:** Carbon Steel

**FINISH:** Chromium-(VI) Free plating / ROHS compliant

**VERSIONS:** Stainless Steel (add an 'S' at the end of the REFERENCE)

**NOTES:** On larger sizes nuts can be supplied with Trust-Wire Nut (W)



# Interlock 45° Swept Female BSP Parallel Pipe with O-ring Swivel (DKOR 45°)

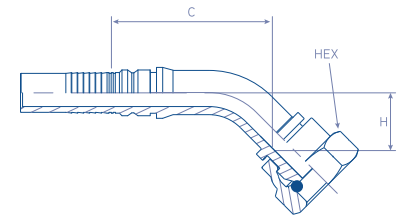

26.3142.

ISO 12151-6 / ISO 8434-6 / BS 5200

	hose	hose Ø	thread	C Cut Off	H	HEX
REFERENCE	dash	inch	inch	mm	mm	mm
26.3142.1212	-12	3/4"	3/4" - 14	67.6	28.3	32
26.3142.1616	-16	1"	1" - 11	80.7	33.8	38
26.3142.2020	-20	1.1/4"	1.1/4" - 11	94.5	37.5	50
26.3142.2424	-24	1.1/2"	1.1/2" - 11	116.5	49.2	55
26.3142.3232	-32	2"	2" - 11	136.5	59.6	70

**MATERIAL:** Carbon Steel

**FINISH:** Chromium-(VI) Free plating /  
ROHS compliant

**VERSIONS:** Stainless Steel (add an 'S'  
at the end of the REFERENCE)

**NOTES:** On larger sizes nuts can be  
supplied with Trust-Wire Nut (W)

# Interlock 90° Swept Female BSP Parallel Pipe with O-ring Swivel (DKOR 90°)

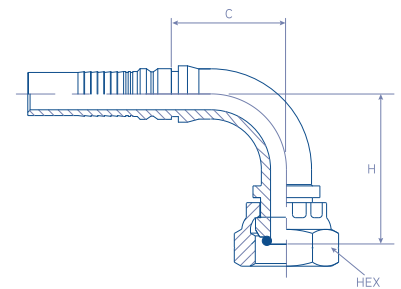

26.3192.

ISO 12151-6 / ISO 8434-6 / BS 5200

	hose	hose Ø	thread	C Cut Off	H	HEX
REFERENCE	dash	inch	inch	mm	mm	mm
26.3192.1212	-12	3/4"	3/4" - 14	57.0	55.0	32
26.3192.1616	-16	1"	1" - 11	73.0	71.0	38
26.3192.2020	-20	1.1/4"	1.1/4" - 11	87.0	77.0	50
26.3192.2424	-24	1.1/2"	1.1/2" - 11	105.0	100.0	55
26.3192.3232	-32	2"	2" - 11	135.0	128.0	70

**MATERIAL:** Carbon Steel

**FINISH:** Chromium-(VI) Free plating /  
ROHS compliant

**VERSIONS:** Stainless Steel (add an 'S'  
at the end of the REFERENCE)

**NOTES:** On larger sizes nuts can be  
supplied with Trust-Wire Nut (W)



# Interlock Male JIC 37° (AGJ)

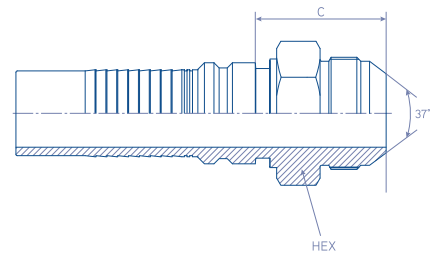

26.2000.

ISO 12151-5 / ISO 8434-2 / SAE J516 / SAE J514

REFERENCE	hose dash	hose Ø inch	thread inch	C Cut Off mm	HEX mm
26.2000.1212	-12	3/4"	1.1/16" - 12	38.0	27
26.2000.1616	-16	1"	1.5/16" - 12	43.1	36
26.2000.2020	-20	1.1/4"	1.5/8" - 12	48.0	46
26.2000.2424	-24	1.1/2"	1.7/8" - 12	52.5	50
26.2000.3232	-32	2"	2.1/2" - 12	64.0	65

**MATERIAL:** Carbon Steel

**FINISH:** Chromium-(VI) Free plating / ROHS compliant

**VERSIONS:** Stainless Steel (add an 'S' at the end of the REFERENCE)

# Interlock Female JIC 37° Swivel (DKJ)

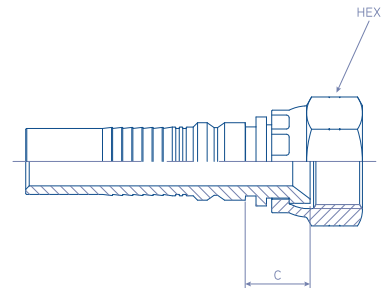

26.4012.

ISO 12151-5 / ISO 8434-2 / SAE J516 / SAE J514

REFERENCE	hose dash	hose Ø inch	thread inch	C Cut Off mm	HEX mm
26.4012.1212	-12	3/4"	1.1/16" - 12	20.0	32
26.4012.1616	-16	1"	1.5/16" - 12	22.3	41
26.4012.2020	-20	1.1/4"	1.5/8" - 12	22.2	50
26.4012.2424	-24	1.1/2"	1.7/8" - 12	23.5	57
26.4012.3232	-32	2"	2.1/2" - 12	30.5	75

**MATERIAL:** Carbon Steel

**FINISH:** Chromium-(VI) Free plating / ROHS compliant

**VERSIONS:** Stainless Steel (add an 'S' at the end of the REFERENCE)

**NOTES:** On larger sizes nuts can be supplied with Trust-Wire Nut (W)



# Interlock 45° Swept Female JIC 37° Swivel (DKJ 45°)

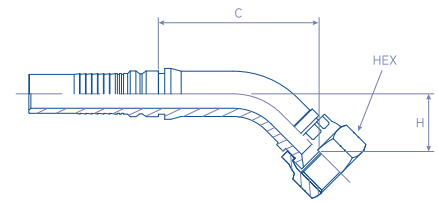

26.4042.

ISO 12151-5 / ISO 8434-2 / SAE J516 / SAE J514

	hose	hose Ø	thread	C Cut Off	H	HEX
REFERENCE	dash	inch	inch	mm	mm	mm
26.4042.1212	-12	3/4"	1.1/16" - 12	68.0	28.3	32
26.4042.1616	-16	1"	1.5/16" - 12	81.0	32.0	38
26.4042.2020	-20	1.1/4"	1.5/8" - 12	94.5	37.5	50
26.4042.2424	-24	1.1/2"	1.7/8" - 12	116.5	49.2	55
26.4042.3232	-32	2"	2.1/2" - 12	148.0	64.0	75

**MATERIAL:** Carbon Steel

**FINISH:** Chromium-(VI) Free plating /  
ROHS compliant

**VERSIONS:** Stainless Steel (add an 'S'  
at the end of the REFERENCE)

**NOTES:** On larger sizes nuts can be  
supplied with Trust-Wire Nut (W)

# Interlock 90° Swept Female JIC 37° Swivel (DKJ 90°)

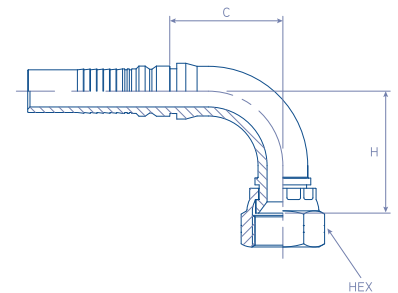

26.4092.

ISO 12151-5 / ISO 8434-2 / SAE J516 / SAE J514

	hose	hose Ø	thread	C Cut Off	H	HEX
REFERENCE	dash	inch	inch	mm	mm	mm
26.4092.1212	-12	3/4"	1.1/16" - 12	59.0	55.0	32
26.4092.1616	-16	1"	1.5/16" - 12	75.0	71.0	38
26.4092.2020	-20	1.1/4"	1.5/8" - 12	89.0	77.0	50
26.4092.2424	-24	1.1/2"	1.7/8" - 12	107.0	100.0	57
26.4092.3232	-32	2"	2.1/2" - 12	135.0	140.0	75

**MATERIAL:** Carbon Steel

**FINISH:** Chromium-(VI) Free plating /  
ROHS compliant

**VERSIONS:** Stainless Steel (add an 'S'  
at the end of the REFERENCE)

**NOTES:** On larger sizes nuts can be  
supplied with Trust-Wire Nut (W)

# Interlock Male NPTF Pipe (AGN)

26.0400.

SAE J516 / SAE J476A

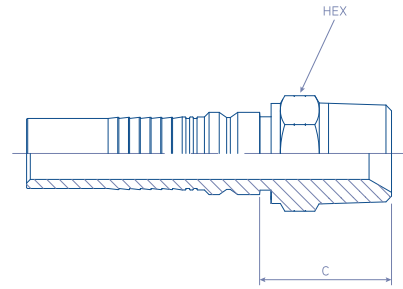

REFERENCE	hose dash	hose Ø inch	thread inch	C Cut Off mm	HEX mm
26.0400.1212	-12	3/4"	3/4" - 14	36.0	27
26.0400.1616	-16	1"	1" - 11.1/2	46.0	36
26.0400.2020	-20	1.1/4"	1.1/4" - 11.1/2	50.7	46
26.0400.2424	-24	1.1/2"	1.1/2" - 11.1/2	50.5	50
26.0400.3232	-32	2"	2" - 11.1/2	57.5	65

**MATERIAL:** Carbon Steel

**FINISH:** Chromium-(VI) Free plating / ROHS compliant

**VERSIONS:** Stainless Steel (add an 'S' at the end of the REFERENCE)

# Interlock Female ORFS Swivel

26.4414.

ISO 12151-1 / ISO 8434-3 / SAE J516

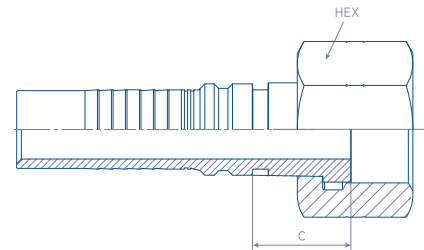

REFERENCE	hose dash	hose Ø inch	thread inch	C Cut Off mm	HEX mm
26.4414.1212	-12	3/4"	1.3/16" - 14	29.0	36
26.4414.1616	-16	1"	1.7/16" - 12	31.6	41
26.4414.2020	-20	1.1/4"	1.11/16" - 12	31.5	50
26.4414.2424	-24	1.1/2"	2" - 12	33.7	50

**MATERIAL:** Carbon Steel

**FINISH:** Chromium-(VI) Free plating / ROHS compliant

**VERSIONS:** Stainless Steel (add an 'S' at the end of the REFERENCE)



# Interlock 45° Swept Female ORFS Swivel

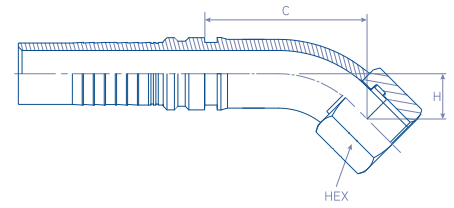

26.4444.

ISO 12151-5 / ISO 8434-2 / SAE J516 / SAE J514

	hose	hose Ø	thread	C Cut Off	H	HEX
REFERENCE	dash	inch	inch	mm	mm	mm
26.4444.1212	-12	3/4"	1.3/16" - 14	60.0	23.1	36
26.4444.1616	-16	1"	1.7/16" - 12	76.0	28.5	41
26.4444.2020	-20	1.1/4"	1.11/16" - 12	95.0	37.0	50
26.4444.2424	-24	1.1/2"	2" - 12	120.0	46.0	60

**MATERIAL:** Carbon Steel

**FINISH:** Chromium-(VI) Free plating / ROHS compliant

**VERSIONS:** Stainless Steel (add an 'S' at the end of the REFERENCE)

# Interlock 90° Swept Female ORFS Swivel

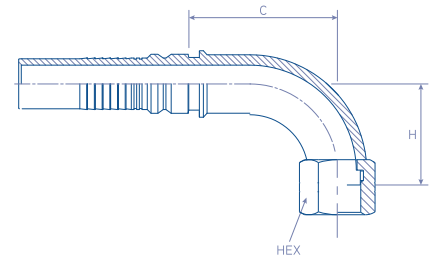

26.4494.

ISO 12151-5 / ISO 8434-2 / SAE J516 / SAE J514

	hose	hose Ø	thread	C Cut Off	H	HEX
REFERENCE	dash	inch	inch	mm	mm	mm
26.4494.1212	-12	3/4"	1.3/16" - 14	56.0	52.0	36
26.4494.1616	-16	1"	1.7/16" - 12	72.0	62.5	41
26.4494.2020	-20	1.1/4"	1.11/16" - 12	86.0	77.0	50
26.4494.2424	-24	1.1/2"	2" - 12	98.0	94.0	60

**MATERIAL:** Carbon Steel

**FINISH:** Chromium-(VI) Free plating / ROHS compliant

**VERSIONS:** Stainless Steel (add an 'S' at the end of the REFERENCE)

# Interlock Straight SAE 3000 PSI (code 61) Flange (SFL)

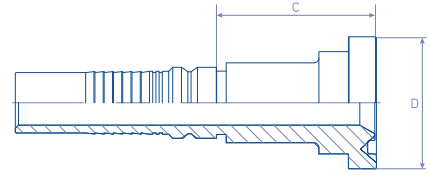

26.7013.

ISO 6162-1 / ISO 12151-3 / SAE J516 / SAE J518

REFERENCE	hose dash	hose Ø inch	D Ø Flange mm	C Cut Off mm
26.7013.1212	-12	3/4"	38.1	40.0
26.7013.1216	-12	3/4"	44.5	43.0
26.7013.1616	-16	1"	44.5	44.5
26.7013.1620	-16	1"	50.8	44.5
26.7013.2020	-20	1.1/4"	50.8	46.7
26.7013.2024	-20	1.1/4"	60.3	49.0
26.7013.2424	-24	1.1/2"	60.3	50.5
26.7013.2432	-24	1.1/2"	71.4	72.0
26.7013.3232	-32	2"	71.4	73.5

**MATERIAL:** Carbon Steel

**FINISH:** Chromium-(VI) Free plating / ROHS compliant

**VERSIONS:** Stainless Steel (add an 'S' at the end of the REFERENCE)

# Interlock 45° Swept SAE 3000 PSI (code 61) Flange (SFL 45°)

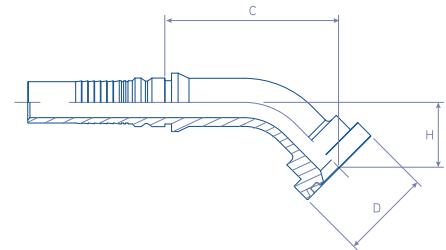

26.7043.

ISO 6162-1 / ISO 12151-3 / SAE J516 / SAE J518

REFERENCE	hose dash	hose Ø inch	D Ø Flange mm	C Cut Off mm	H mm
26.7043.1212	-12	3/4"	38.1	68.5	26.7
26.7043.1216	-12	3/4"	44.5	68.0	30.6
26.7043.1616	-16	1"	44.5	82.5	32.5
26.7043.1620	-16	1"	50.8	83.0	34.5
26.7043.2020	-20	1.1/4"	50.8	84.3	31.0
26.7043.2024	-20	1.1/4"	60.3	87.1	31.0
26.7043.2424	-24	1.1/2"	60.3	123.0	46.5
26.7043.2432	-24	1.1/2"	71.4	123.5	50.5
26.7043.3232	-32	2"	71.4	140.0	53.2

**MATERIAL:** Carbon Steel

**FINISH:** Chromium-(VI) Free plating / ROHS compliant

**VERSIONS:** Stainless Steel (add an 'S' at the end of the REFERENCE)



# Interlock 90° Swept SAE 3000 PSI (code 61) Flange (SFL 90°)

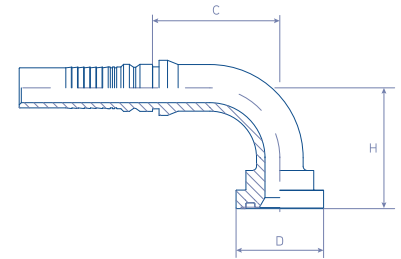

26.7093.

ISO 6162-1 / ISO 12151-3 / SAE J516 / SAE J518

REFERENCE	hose dash	hose Ø inch	D Ø Flange mm	C Cut Off mm	H mm
26.7093.1212	-12	3/4"	38.1	63.0	56.5
26.7093.1216	-12	3/4"	44.5	58.0	58.0
26.7093.1616	-16	1"	44.5	75.0	65.0
26.7093.1620	-16	1"	50.8	67.5	61.0
26.7093.2020	-20	1.1/4"	50.8	83.7	69.2
26.7093.2024	-20	1.1/4"	60.3	82.3	69.2
26.7093.2424	-24	1.1/2"	60.3	109.0	90.0
26.7093.2432	-24	1.1/2"	71.4	109.0	104.0
26.7093.3232	-32	2"	71.4	145.0	123.0

**MATERIAL:** Carbon Steel

**FINISH:** Chromium-(VI) Free plating /  
ROHS compliant

**VERSIONS:** Stainless Steel (add an 'S'  
at the end of the REFERENCE)

# Interlock Straight SAE 6000 PSI (code 62) Flange (SFS)

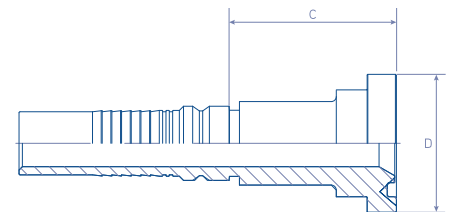

26.7016.

ISO 6162-1 / ISO 12151-3 / SAE J516 / SAE J518

REFERENCE	hose dash	hose Ø inch	D Ø Flange mm	C Cut Off mm
26.7016.1212	-12	3/4"	41.3	46.0
26.7016.1216	-12	3/4"	47.6	56.5
26.7016.1616	-16	1"	47.6	57.5
26.7016.1620	-16	1"	54.0	64.5
26.7016.2020	-20	1.1/4"	54.0	67.2
26.7016.2024	-20	1.1/4"	63.5	71.0
26.7016.2424	-24	1.1/2"	63.5	73.0
26.7016.2432	-24	1.1/2"	79.4	75.0
26.7016.3232	-32	2"	79.4	83.5

**MATERIAL:** Carbon Steel

**FINISH:** Chromium-(VI) Free plating /  
ROHS compliant

**VERSIONS:** Stainless Steel (add an 'S'  
at the end of the REFERENCE)

# Interlock 45° Swept SAE 6000 PSI (code 62) Flange (SFS 45°)

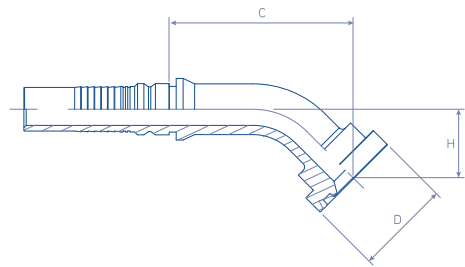

26.7046.

ISO 6162-1 / ISO 12151-3 / SAE J516 / SAE J518

REFERENCE	hose dash	hose Ø inch	D Ø Flange mm	C Cut Off mm	H mm
26.7046.1212	-12	3/4"	41.3	69.0	29.5
26.7046.1216	-12	3/4"	47.6	77.0	33.0
26.7046.1616	-16	1"	47.6	79.0	31.0
26.7046.1620	-16	1"	54.0	99.0	39.0
26.7046.2020	-20	1.1/4"	54.0	110.0	44.0
26.7046.2024	-20	1.1/4"	63.5	112.7	48.0
26.7046.2424	-24	1.1/2"	63.5	115.0	47.0
26.7046.2432	-24	1.1/2"	79.4	131.3	57.0
26.7046.3232	-32	2"	79.4	154.0	64.0

**MATERIAL:** Carbon Steel

**FINISH:** Chromium-(VI) Free plating / ROHS compliant

**VERSIONS:** Stainless Steel (add an 'S' at the end of the REFERENCE)

# Interlock 90° Swept SAE 6000 PSI (code 62) Flange (SFS 90°)

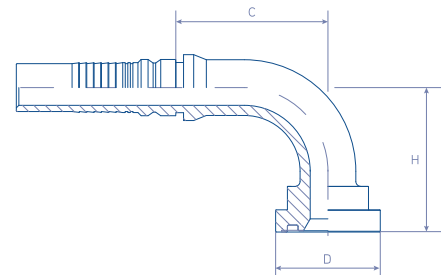

26.7096.

ISO 6162-1 / ISO 12151-3 / SAE J516 / SAE J518

REFERENCE	hose dash	hose Ø inch	D Ø Flange mm	C Cut Off mm	H mm
26.7096.1212	-12	3/4"	41.3	55.0	58.0
26.7096.1216	-12	3/4"	47.6	58.0	65.0
26.7096.1616	-16	1"	47.6	77.0	66.0
26.7096.1620	-16	1"	54.0	76.0	80.0
26.7096.2020	-20	1.1/4"	54.0	97.2	86.0
26.7096.2024	-20	1.1/4"	63.5	99.9	100.0
26.7096.2424	-24	1.1/2"	63.5	108.5	104.0
26.7096.2432	-24	1.1/2"	79.4	107.5	119.5
26.7096.3232	-32	2"	79.4	145.0	134.0

**MATERIAL:** Carbon Steel

**FINISH:** Chromium-(VI) Free plating / ROHS compliant

**VERSIONS:** Stainless Steel (add an 'S' at the end of the REFERENCE)



# Interlock Straight SUPERCAT Flange

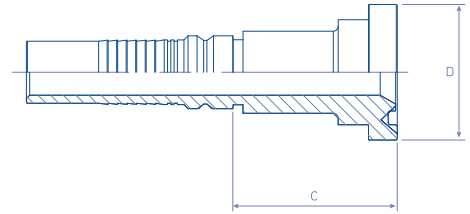

26.7116.

ISO 6162-2 / ISO 12151-3 / SAE J516 / SAE J518

REFERENCE	hose dash	hose Ø inch	D Ø Flange mm	C Cut Off mm
26.7116.1212	-12	3/4"	41.3	50.0
26.7116.1216	-12	3/4"	47.6	64.0
26.7116.1616	-16	1"	47.6	65.0
26.7116.1620	-16	1"	54.0	71.0
26.7116.2020	-20	1.1/4"	54.0	73.0
26.7116.2024	-20	1.1/4"	63.5	84.0
26.7116.2424	-24	1.1/2"	63.5	77.0
26.7116.2432	-24	1.1/2"	79.4	82.0
26.7116.3232	-32	2"	79.4	90.0

**MATERIAL:** Carbon Steel

**FINISH:** Chromium-(VI) Free plating /  
ROHS compliant

**VERSIONS:** Stainless Steel (add an 'S'  
at the end of the REFERENCE)

# Interlock 45° Swept SUPERCAT Flange

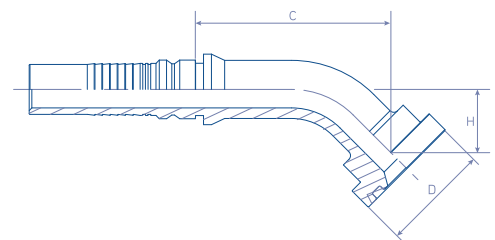

26.7146.

ISO 6162-2 / ISO 12151-3 / SAE J516 / SAE J518

REFERENCE	hose dash	hose Ø inch	D Ø Flange mm	C Cut Off mm	H mm
26.7146.1212	-12	3/4"	41.3	72.0	32.0
26.7146.1216	-12	3/4"	47.6	79.0	36.0
26.7146.1616	-16	1"	47.6	83.0	34.0
26.7146.1620	-16	1"	54.0	95.0	41.0
26.7146.2020	-20	1.1/4"	54.0	114.0	46.0
26.7146.2024	-20	1.1/4"	63.5	116.0	48.0
26.7146.2424	-24	1.1/2"	63.5	120.0	48.0
26.7146.2432	-24	1.1/2"	79.4	132.0	59.0
26.7146.3232	-32	2"	79.4	170.0	63.0

**MATERIAL:** Carbon Steel

**FINISH:** Chromium-(VI) Free plating /  
ROHS compliant

**VERSIONS:** Stainless Steel (add an 'S'  
at the end of the REFERENCE)



# Interlock 90° Swept SUPERCAT Flange

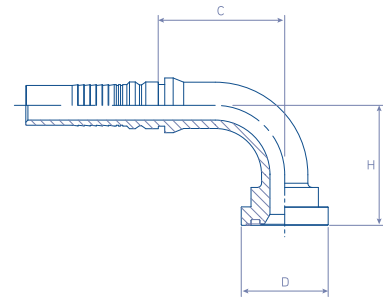

26.7196.

ISO 6162-2 / ISO 12151-3 / SAE J516 / SAE J518

	hose	hose Ø	D Ø Flange	C Cut Off	H
REFERENCE	dash	inch	mm	mm	mm
26.7196.1212	-12	3/4"	41.3	57.0	60.0
26.7196.1216	-12	3/4"	47.6	57.0	68.0
26.7196.1616	-16	1"	47.6	78.0	70.0
26.7196.1620	-16	1"	54.0	78.0	82.0
26.7196.2020	-20	1.1/4"	54.0	106.0	90.0
26.7196.2024	-20	1.1/4"	63.5	106.0	100.0
26.7196.2424	-24	1.1/2"	63.5	113.0	106.0
26.7196.2432	-24	1.1/2"	79.4	113.0	122.0
26.7196.3232	-32	2"	79.4	153.0	134.0

**MATERIAL:** Carbon Steel

**FINISH:** Chromium-(VI) Free plating / ROHS compliant

**VERSIONS:** Stainless Steel (add an 'S' at the end of the REFERENCE)

# Interlock Male Metric Heavy Serie 24° Cone Seat (CES)

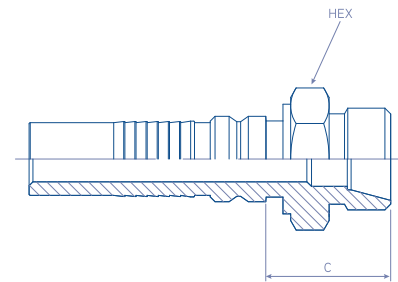

26.1100.

ISO 12151-2 / ISO 8434-1

	hose	hose Ø	thread	d Tube	C Cut Off	HEX
REFERENCE	dash	inch		mm	mm	mm
26.1100.1236	-12	3/4"	M36 x 2.0	25	44.0	41
26.1100.1642	-16	1"	M42 x 2.0	30	42.0	46
26.1100.2052	-20	1.1/4"	M52 x 2.0	38	48.2	55

**MATERIAL:** Carbon Steel

**FINISH:** Chromium-(VI) Free plating / ROHS compliant

**VERSIONS:** Stainless Steel (add an 'S' at the end of the REFERENCE)



# Interlock Female Metric Heavy Serie 24° Cone Seat Swivel (DKOS)

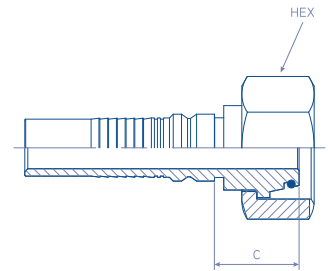

26.5113.

ISO 12151-2 / ISO 8434-1

	hose	hose Ø	thread	d Tube	C Cut Off	HEX
REFERENCE	dash	inch		mm	mm	mm
26.5113.1236	-12	3/4"	M36 x 2.0	25	32.0	46
26.5113.1642	-16	1"	M42 x 2.0	30	35.5	50
26.5113.2052	-20	1.1/4"	M52 x 2.0	30	38.7	60

**MATERIAL:** Carbon Steel

**FINISH:** Chromium-(VI) Free plating /  
ROHS compliant

**VERSIONS:** Stainless Steel (add an 'S'  
at the end of the REFERENCE)

# Interlock 45° Swept Female Metric Heavy Serie 24° Cone Seat Swivel (DKOS 45)

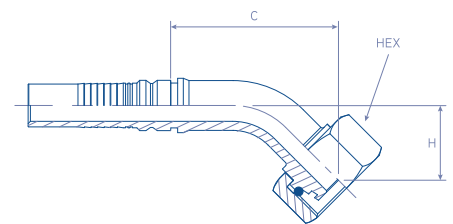

26.5143.

ISO 12151-2 / ISO 8434-1

	hose	hose Ø	thread	d Tube	C Cut Off	H	HEX
REFERENCE	dash	inch		mm	mm	mm	mm
26.5143.1236	-12	3/4"	M36 x 2.0	25	88.0	31.0	46
26.5143.1642	-16	1"	M42 x 2.0	30	93.3	39.0	50
26.5143.2052	-20	1.1/4"	M52 x 2.0	38	115.1	46.5	60

**MATERIAL:** Carbon Steel

**FINISH:** Chromium-(VI) Free plating /  
ROHS compliant

**VERSIONS:** Stainless Steel (add an 'S'  
at the end of the REFERENCE)

# Interlock 90° Swept Female Metric Heavy Serie 24° Cone Seat Swivel (DKOS 90)

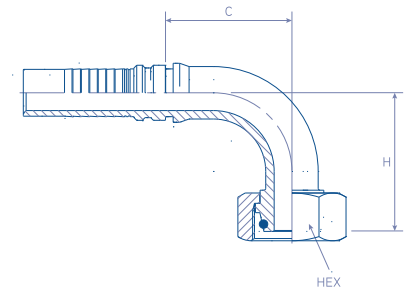

26.5193.

ISO 12151-2 / ISO 8434-1

	hose	hose Ø	thread	d Tube	C Cut Off	H	HEX
REFERENCE	dash	inch		mm	mm	mm	mm
26.5193.1236	-12	3/4"	M36 x 2.0	25	56.0	60.0	46
26.5193.1642	-16	1"	M42 x 2.0	30	76.0	75.0	50
26.5193.2052	-20	1.1/4"	M52 x 2.0	38	92.0	96.0	60

**MATERIAL:** Carbon Steel

**FINISH:** Chromium-(VI) Free plating /  
ROHS compliant

**VERSIONS:** Stainless Steel (add an 'S'  
at the end of the REFERENCE)

## **PRODUCTS LIMITED WARRANTY**

The products sold by Balflex® are warranted to our customers to be free from defects in material and workmanship when shipment at Balflex® warehouses takes place.

All warranty claims shall be made present in writing to Balflex®. Balflex® liability hereunder is limited to the purchase price of the merchandise proving to be defective or, at balflex sole discretion, to the replacement of such merchandise upon its authorized return to Balflex®.

This warranty is in lieu of and excludes all other warranties, or conditions expressed, implied, statutory or otherwise created under applicable law including, but not limited to the warranty of merchantability and the warranty of fitness for a particular purpose.

In addition, this warranty shall not apply and will be null and void to any products or portions thereof that have been subject to abuse, misuse, improper installation, maintenance or operation, electrical failure or abnormal conditions and to products that have been tampered with, altered, modified, repaired, reworked by anyone not approved by balflex or used in any other manner inconsistent with any Balflex® instructions or specifications. Balflex® disclaims any liability for any hose assemblies which have not been produced with in conformance with Balflex® assembly recommendations and parts.

In no event shall balflex have any liability whatsoever to any person, including without limitation, any immediate buyer, purchaser or other third party, for any special, punitive, incidental or consequential damages, including without limitation, profit loss or customer loss, loss or damage to physical property of customer or any other person and loss of anticipated revenue, profits, goodwill, savings or other economic loss of customer or any other person.

Specification subject to change without prior notice.  
Errors and omission excluded.



## U.S.A. and Canada

6000 South Loop East Freeway  
Houston, Tx 77033  
United States of America  
Tel: (1) 713-928-6064  
Email: [sales@balflex.com](mailto:sales@balflex.com)  
[www.balflexusa.com](http://www.balflexusa.com)

## Europe Headquarters

R. Bouça dos Estilhadouros, 226/254  
4445-044 Alfena, Portugal  
Tel: (351) 229 698 160  
Email: [balflex@balflex.com](mailto:balflex@balflex.com)  
[www.balflex.com](http://www.balflex.com)

## Germany

Franckensteinstraße 8  
77749 Hohberg  
Tel: (49) 07808 4318857  
Email: [info@2bhydraulik.de](mailto:info@2bhydraulik.de)  
[www.balflex.com](http://www.balflex.com)

## South America

R. Padre Cesari Lelli, 1014  
Rodovia BR-116  
CEP 83420-000 Quatro Barras/PR  
Brasil  
Tel: (55) 41 3671 3450  
Email: [comercial@balflex.com.br](mailto:comercial@balflex.com.br)  
[www.balflex.com](http://www.balflex.com)

[www.balflex.com](http://www.balflex.com)

An ISO 9001:2015 Company:



Cofinanciado por:



UNIÃO EUROPEIA  
Fundo Europeu  
de Desenvolvimento Regional

